

# P10

**workshop tool trolley**  
with 397 tools for 7 drawers  
**810.7397**

---

**Workshop trolley P10**

with 8 compartments

873.0008

# THE ENTRY MODEL TO SATISFY HIGH STANDARDS



P10



**DUO Lock** Brilliant locking system



**Eight drawers** each load capacity up to 50 kg



Stable **ball bearing**



**Stainless steel surface**



**Lock** lockable



**Anti-static castors** with brakes



Integrated **corner protection**



**Paper roll holder** included



**Can holder** included

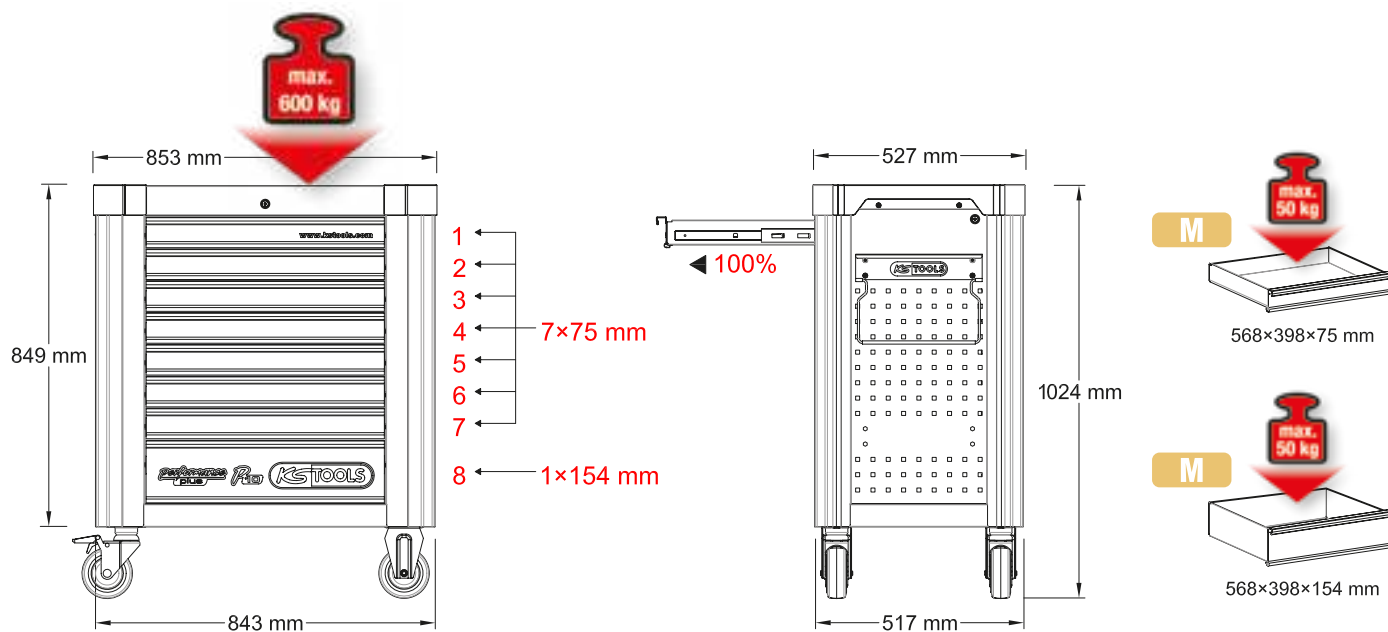

# P10 workshop tool trolley set with 397 tools for 7 drawers

810.7397



397

M

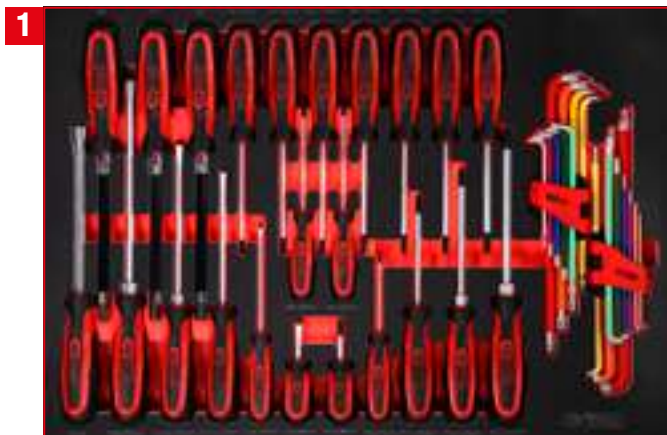

1  
Screw spanner set in foam  
insert

811.0041



41



2  
1/4" + 3/8" + 1/2" socket  
spanner set in foam insert

811.0111



111



1/2" screwdriver bit set in foam insert

811.1111



Screw spanner set in foam insert

811.1041



Pliers and file set in foam insert

811.0019



Oil and tyre servicing set in foam insert

811.0043



Hammer and chisel set in foam insert

811.0022



P 10

P 15

P 20

P 25

P 30

P 35

P 40

P 45

Single inserts

Individual parts

Accessories

**M** Screwdriver set

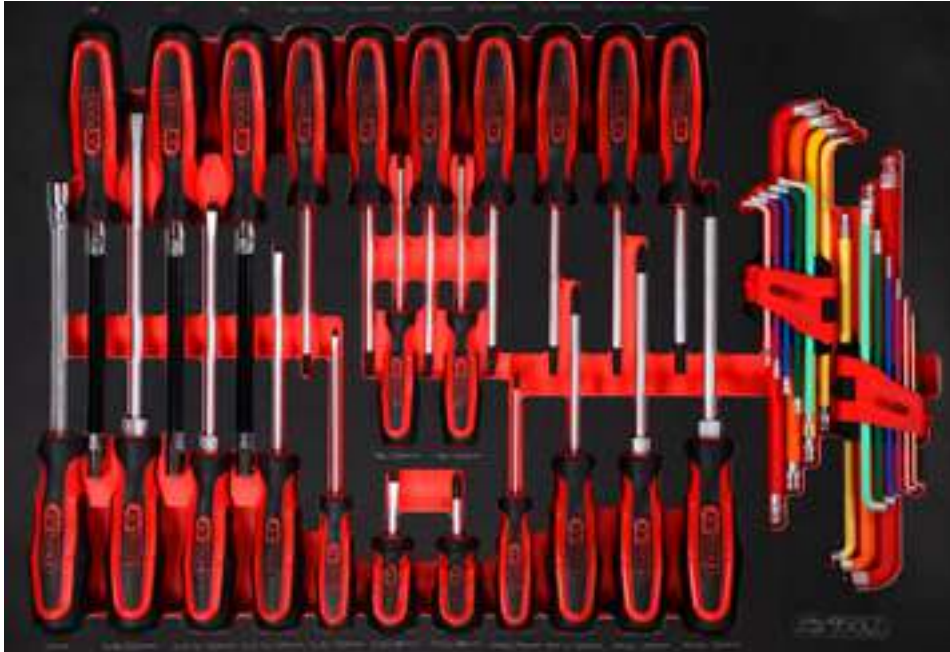

Pos.	Code	Description	pcs
1	911.1128	ERGOTORQUE Socket screwdriver, 8 mm	1
2	159.1127	ERGOTORQUEplus Socket screwdriver, 7 mm	1
3	159.1126	ERGOTORQUEplus Socket screwdriver, 6 mm	1
4	159.1032	ERGOTORQUEplus screwdriver, Torx, T10	1
5	159.1033	ERGOTORQUEplus screwdriver, Torx, T15	1
6	159.1034	ERGOTORQUEplus screwdriver, Torx, T20	1
7	159.1035	ERGOTORQUEplus screwdriver, Torx, T25	1
8	159.1036	ERGOTORQUEplus screwdriver, Torx, T27	1
9	159.1037	ERGOTORQUEplus screwdriver, Torx, T30	1
10	159.1038	ERGOTORQUEplus screwdriver, Torx, T40	1
11	159.1208	ERGOTORQUEplus socket screwdriver, 10 mm	1
12	159.1011	ERGOTORQUEplus screwdriver for slotted screws, 8 mm, 315 mm	1
13	159.1009	ERGOTORQUEplus screwdriver for slotted screws, 6,5 mm, 255 mm	1
14	159.1006	ERGOTORQUEplus screwdriver for slotted screws, 5,5 mm, 230 mm	1
15	159.1004	ERGOTORQUEplus screwdriver for slotted screws, 4 mm, 180 mm	1
16	159.1030	ERGOTORQUEplus screwdriver, Torx, T8	1
17	159.1031	ERGOTORQUEplus screwdriver, Torx, T9	1
18	159.1001	ERGOTORQUEplus screwdriver for slotted screws, 6 mm, stubby	1
19	159.1026	ERGOTORQUEplus screwdriver for screws PH, PH2, stubby	1
20	159.1027	ERGOTORQUEplus screwdriver for screws PH, PH0, 155 mm	1
21	159.1029	ERGOTORQUEplus screwdriver for screws PH, PH1, 205 mm	1
22	159.1022	ERGOTORQUEplus screwdriver for screws PH, PH2, 230 mm	1
23	159.1024	ERGOTORQUEplus screwdriver for screws PH, PH3, 265 mm	1
24	151.4530	Ball ended Torx key wrench set, extra long and bent 108°, 9 pcs	9
25	151.4560	Ball ended hexagon key wrench set, 108° angled, 9 pcs	9

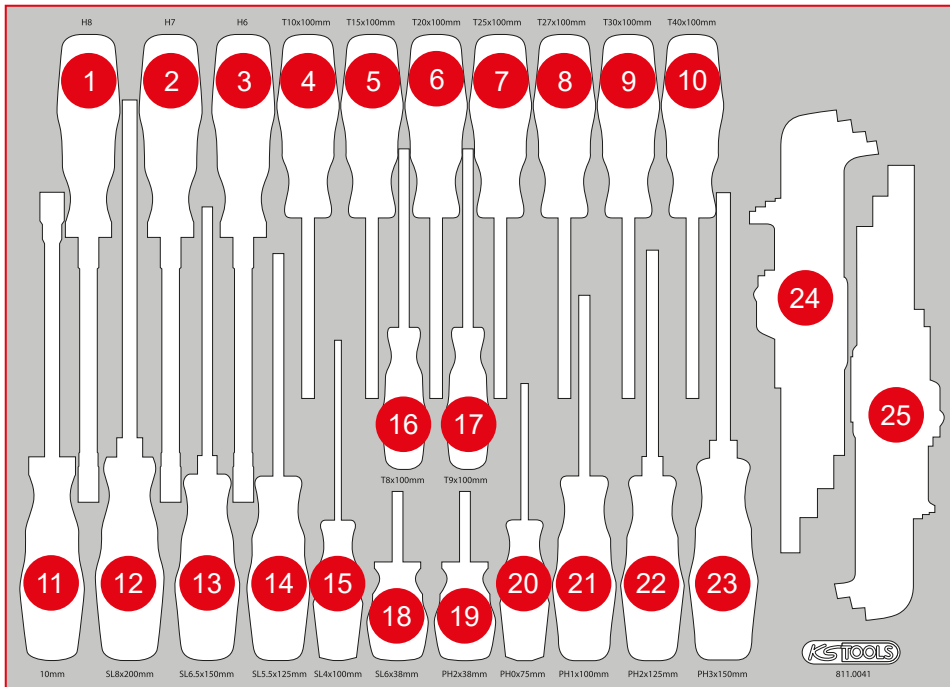

811.0111

**M** 1/4" + 3/8" + 1/2" Socket spanner set



Pos.	Code	Description	pcs	Pos.	Code	Description	pcs	Pos.	Code	Description	pcs
1	911.1462	1/4" Bit socket Torx tamperproof, TB10	1	21	911.1440	1/4" Bit socket hexagon, 7 mm	1	41	917.1404	1/4" Hexagonal socket, 4 mm	1
2	911.1463	1/4" Bit socket Torx tamperproof, TB15	1	22	911.1701	1/4" Bit socket five star tamperproof, TS10	1	42	917.1405	1/4" Hexagonal socket, 5 mm	1
3	911.1464	1/4" Bit socket Torx tamperproof, TB20	1	23	911.1702	1/4" Bit socket five star tamperproof, TS15	1	43	917.1406	1/4" Hexagonal socket, 6 mm	1
4	911.1465	1/4" Bit socket Torx tamperproof, TB25	1	24	911.1703	1/4" Bit socket five star tamperproof, TS20	1	44	917.1407	1/4" Hexagonal socket, 7 mm	1
5	911.1466	1/4" Bit socket Torx tamperproof, TB27	1	25	911.1704	1/4" Bit socket five star tamperproof, TS25	1	45	917.1408	1/4" Hexagonal socket, 8 mm	1
6	911.1467	1/4" Bit socket Torx tamperproof, TB30	1	26	911.1705	1/4" Bit socket five star tamperproof, TS27	1	46	917.1409	1/4" Hexagonal socket, 9 mm	1
7	911.1468	1/4" Bit socket Torx tamperproof, TB40	1	27	911.1706	1/4" Bit socket five star tamperproof, TS30	1	47	917.1410	1/4" Hexagonal socket, 10 mm	1
8	911.1442	1/4" Bit socket Torx, T10	1	28	911.1707	1/4" Bit socket five star tamperproof, TS40	1	48	917.1411	1/4" Hexagonal socket, 11 mm	1
9	911.1443	1/4" Bit socket Torx, T15	1	29	917.3812	3/8" Hexagonal socket, 12 mm	1	49	917.1412	1/4" Hexagonal socket, 12 mm	1
10	911.1444	1/4" Bit socket Torx, T20	1	30	917.3813	3/8" Hexagonal socket, 13 mm	1	50	917.1413	1/4" Hexagonal socket, 13 mm	1
11	911.1445	1/4" Bit socket Torx, T25	1	31	917.3814	3/8" Hexagonal socket, 14 mm	1	51	917.1221	1/2" Hexagonal socket, 21 mm	1
12	911.1449	1/4" Bit socket Torx, T27	1	32	917.3815	3/8" Hexagonal socket, 15 mm	1	52	917.1222	1/2" Hexagonal socket, 22 mm	1
13	911.1446	1/4" Bit socket Torx, T30	1	33	917.3816	3/8" Hexagonal socket, 16 mm	1	53	917.1224	1/2" Hexagonal socket, 24 mm	1
14	911.1447	1/4" Bit socket Torx, T40	1	34	917.3817	3/8" Hexagonal socket, 17 mm	1	54	917.1343	1/2" Hexagonal socket, 26 mm	1
15	911.1419	1/4" Bit socket slot, 5,5 mm	1	35	917.3818	3/8" Hexagonal socket, 18 mm	1	55	917.1227	1/2" Hexagonal socket, 27 mm	1
16	911.1416	1/4" Bit socket, PH2	1	36	917.3819	3/8" Hexagonal socket, 19 mm	1	56	917.1344	1/2" Hexagonal socket, 28 mm	1
17	911.1436	1/4" Bit socket hexagon, 3 mm	1	37	917.3808	3/8" Hexagonal socket, 8 mm	1	57	917.1230	1/2" Hexagonal socket, 30 mm	1
18	911.1437	1/4" Bit socket hexagon, 4 mm	1	38	917.3809	3/8" Hexagonal socket, 9 mm	1	58	917.1232	1/2" Hexagonal socket, 32 mm	1
19	911.1438	1/4" Bit socket hexagon, 5 mm	1	39	917.3810	3/8" Hexagonal socket, 10 mm	1	59	917.1210	1/2" Hexagonal socket, 10 mm	1
20	911.1439	1/4" Bit socket hexagon, 6 mm	1	40	917.3811	3/8" Hexagonal socket, 11 mm	1	60	917.1211	1/2" Hexagonal socket, 11 mm	1

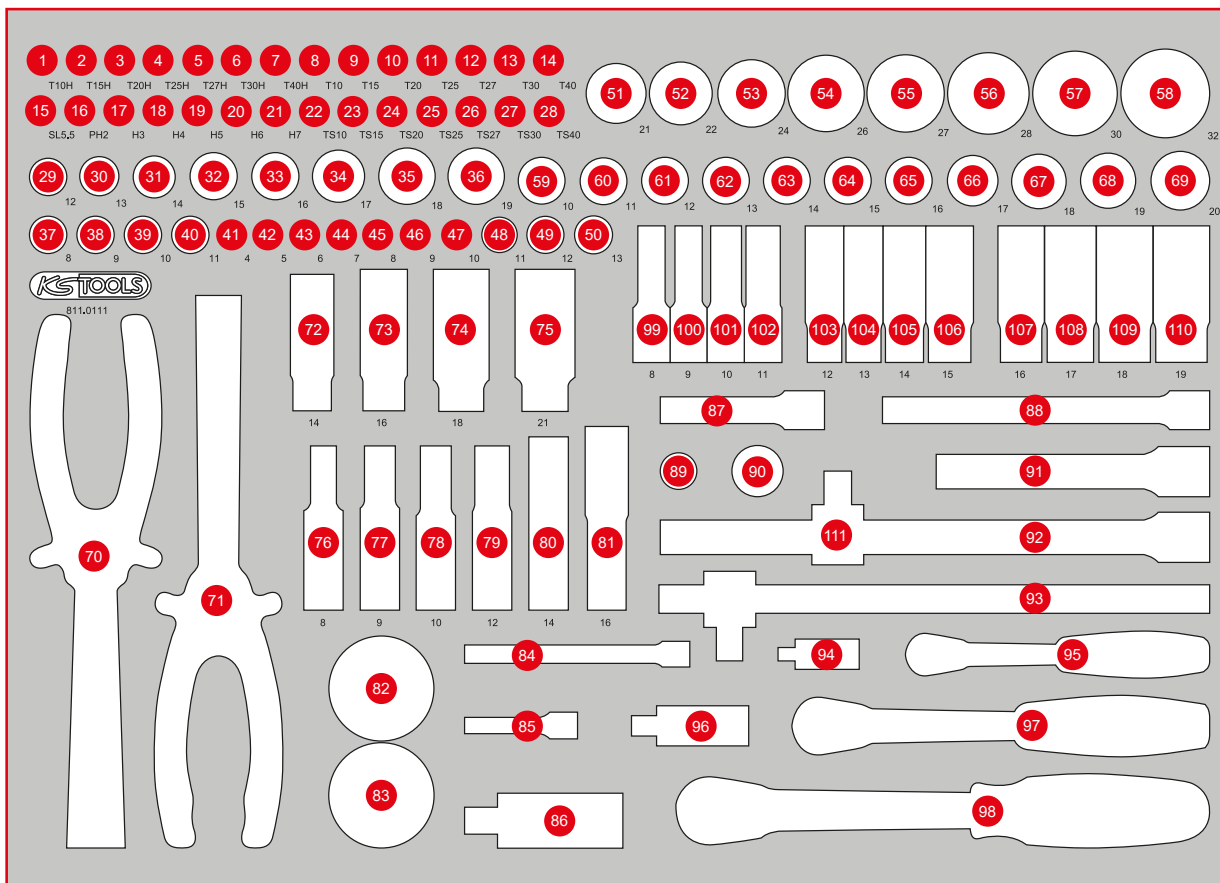

Pos.	Code	Description	pcs	Pos.	Code	Description	pcs	Pos.	Code	Description	pcs
61	917.1212	1/2" Hexagonal socket, 12 mm	1	79	500.7304	3/8" Glow plug joint sockets, short, 75 mm, 12 mm	1	96	911.3850	3/8" Universal joint	1
62	917.1213	1/2" Hexagonal socket, 13 mm	1	80	500.7305	3/8" Glow plug joint sockets, short, 75 mm, 14 mm	1	97	920.3890	3/8" SlimPOWER Reversible ratchet, 72 teeth	1
63	917.1214	1/2" Hexagonal socket, 14 mm	1	81	500.7306	3/8" Glow plug joint sockets, short, 75 mm, 16 mm	1	98	920.1290	1/2" SlimPOWER Reversible ratchet, 72 teeth	1
64	917.1215	1/2" Hexagonal socket, 15 mm	1	82	914.1410	Mini hand reversible ratchet, 1/4", 72 teethh	1	99	917.3828	3/8" Hexagonal socket, deep, 8 mm	1
65	917.1216	1/2" Hexagonal socket, 16 mm	1	83	914.3810	Mini hand reversible ratchet, 3/8", 72 teethh	1	100	917.3829	3/8" Hexagonal socket, deep, 9 mm	1
66	917.1217	1/2" Hexagonal socket, 17 mm	1	84	911.1424	1/4" Extension with hexagon drive, 100 mm	1	101	917.3830	3/8" Hexagonal socket, deep, 10 mm	1
67	917.1218	1/2" Hexagonal socket, 18 mm	1	85	911.1423	1/4" Extension with hexagon drive, 50 mm	1	102	917.3831	3/8" Hexagonal socket, deep, 11 mm	1
68	917.1219	1/2" Hexagonal socket, 19 mm	1	86	911.1250	1/2" Universal joint	1	103	917.3832	3/8" Hexagonal socket, deep, 12 mm	1
69	917.1220	1/2" Hexagonal socket, 20 mm	1	87	911.3801	3/8" Extension with knurling, 75 mm	1	104	917.3833	3/8" Hexagonal socket, deep, 13 mm	1
70	500.7310	Glow plug pliers, angled, 235 mm	1	88	911.3802	3/8" Extension with knurling, 150 mm	1	105	917.3834	3/8" Hexagonal socket, deep, 14 mm	1
71	500.7330	Glow plug pliers, 265 mm	1	89	911.3897	3/8" Reducing adaptor, 3/8" F x 1/4" M	1	106	917.3835	3/8" Hexagonal socket, deep, 15 mm	1
72	911.3990	3/8" Special spark plug socket, thin-walled, 14 mm	1	90	911.3826	3/8" Slider/Reducing adaptor, 1/2" F x 3/8" M	1	107	917.3836	3/8" Hexagonal socket, deep, 16 mm	1
73	911.3804	3/8" Spark plug socket, 16 mm	1	91	911.1202	1/2" Extensions, 125 mm	1	108	917.3837	3/8" Hexagonal socket, deep, 17 mm	1
74	911.3823	3/8" Spark plug socket, 18 mm	1	92	911.1203	1/2" Extensions, 250 mm	1	109	917.3838	3/8" Hexagonal socket, deep, 18 mm	1
75	911.3805	3/8" Spark plug socket, 21 mm	1	93	911.1204	Sliding T-bar, 1/2", 250 mm	1	110	917.3839	3/8" Hexagonal socket, deep, 19 mm	1
76	500.7301	3/8" Glow plug joint sockets, short, 75 mm, 8 mm	1	94	911.1450	1/4" Universal joint	1	111	911.1207	3/8" Sliding adaptor, 3/8" F x 1/2" M	1
77	500.7302	3/8" Glow plug joint sockets, short, 75 mm, 9 mm	1	95	920.1490	1/4" SlimPOWER Reversible ratchet, 72 teeth	1				
78	500.7303	3/8" Glow plug joint sockets, short, 75 mm, 10 mm	1								

811.1111

**M** 1/2" Screwdriver bit set

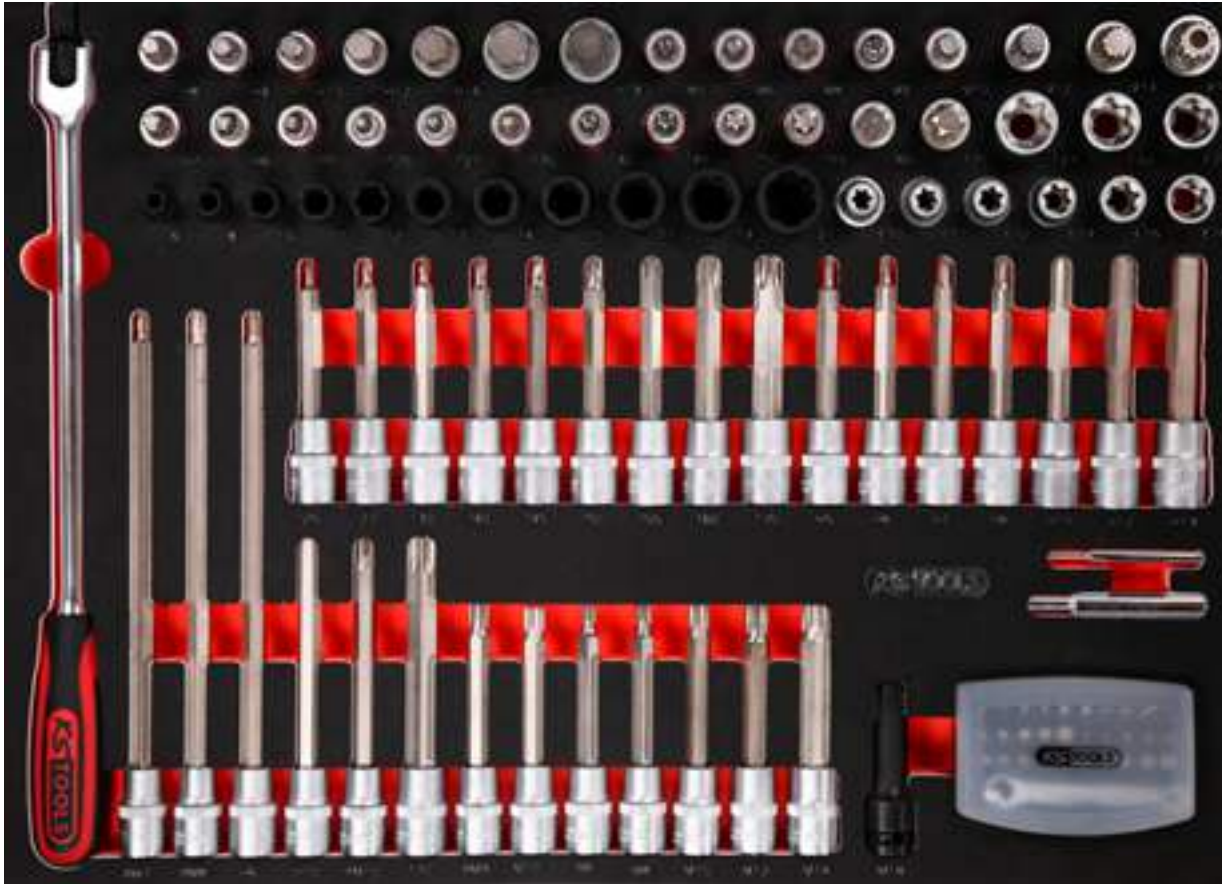
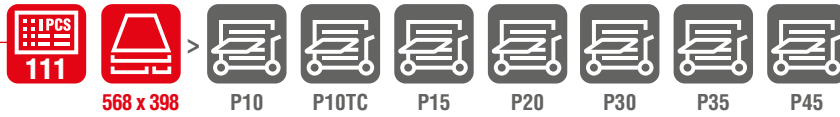

Pos.	Code	Description	pcs	Pos.	Code	Description	pcs	Pos.	Code	Description	pcs
1	917.1455	1/2" Flexi head drive handle	1	15	911.1345	1/2" Bit socket spline (XZN), M14, 55 mm	1	28	911.1370	1/2" Bit socket Torx, T70	1
2	911.1308	1/2" Bit socket hexagon, short, 8 mm	1	16	911.1348	1/2" Bit socket spline (XZN) tamperproof, M16, 55 mm	1	29	911.4326	1/2" Torx E Socket, E24	1
3	911.1309	1/2" Bit socket hexagon, short, 9 mm	1	17	911.1307	1/2" Bit socket hexagon, short, 7 mm	1	30	911.4325	1/2" Torx E Socket, E22	1
4	911.1310	1/2" Bit socket hexagon, short, 10 mm	1	18	911.1306	1/2" Bit socket hexagon, short, 6 mm	1	31	911.4324	1/2" Torx E Socket, E20	1
5	911.1312	1/2" Bit socket hexagon, short, 12 mm	1	19	911.1305	1/2" Bit socket hexagon, short, 5 mm	1	32	913.1473	1/4" Spiral profile impact socket, 6 mm	1
6	911.1314	1/2" Bit socket hexagon, short, 14 mm	1	20	911.1362	1/2" Bit socket Torx, T25	1	33	913.1408	1/4" Spiral profile impact socket, 8 mm	1
7	911.1317	1/2" Bit socket hexagon, short, 17 mm	1	21	911.1363	1/2" Bit socket Torx, T27	1	34	913.1410	1/4" Spiral profile impact socket, 10 mm	1
8	911.1319	1/2" Bit socket hexagon, short, 19 mm	1	22	911.1364	1/2" Bit socket Torx, T30	1	35	913.1470	1/4" Spiral profile impact socket, 11 mm	1
9	911.1340	1/2" Bit socket spline (XZN), M5, 55 mm	1	23	911.1365	1/2" Bit socket Torx, T40	1	36	913.1412	1/4" Spiral profile impact socket, 12 mm	1
10	911.1341	1/2" Bit socket spline (XZN), M6, 55 mm	1	24	911.1366	1/2" Bit socket Torx, T45	1	37	913.1468	1/2" Spiral profile impact socket, 13 mm	1
11	911.1342	1/2" Bit socket spline (XZN), M8, 55 mm	1	25	911.1367	1/2" Bit socket Torx, T50	1	38	913.1467	1/2" Spiral profile impact socket, 14 mm	1
12	911.1313	1/2" Bit socket spline (XZN), M9, 55 mm	1	26	911.1368	1/2" Bit socket Torx, T55	1	39	913.1466	1/2" Spiral profile impact socket, 15 mm	1
13	911.1343	1/2" Bit socket spline (XZN), M10, 55 mm	1	27	911.1369	1/2" Bit socket Torx, T60	1	40	913.1465	1/2" Spiral profile impact socket, 17 mm	1
14	911.1344	1/2" Bit socket spline (XZN), M12, 55 mm	1					41	913.1464	1/2" Spiral profile impact socket, 19 mm	1

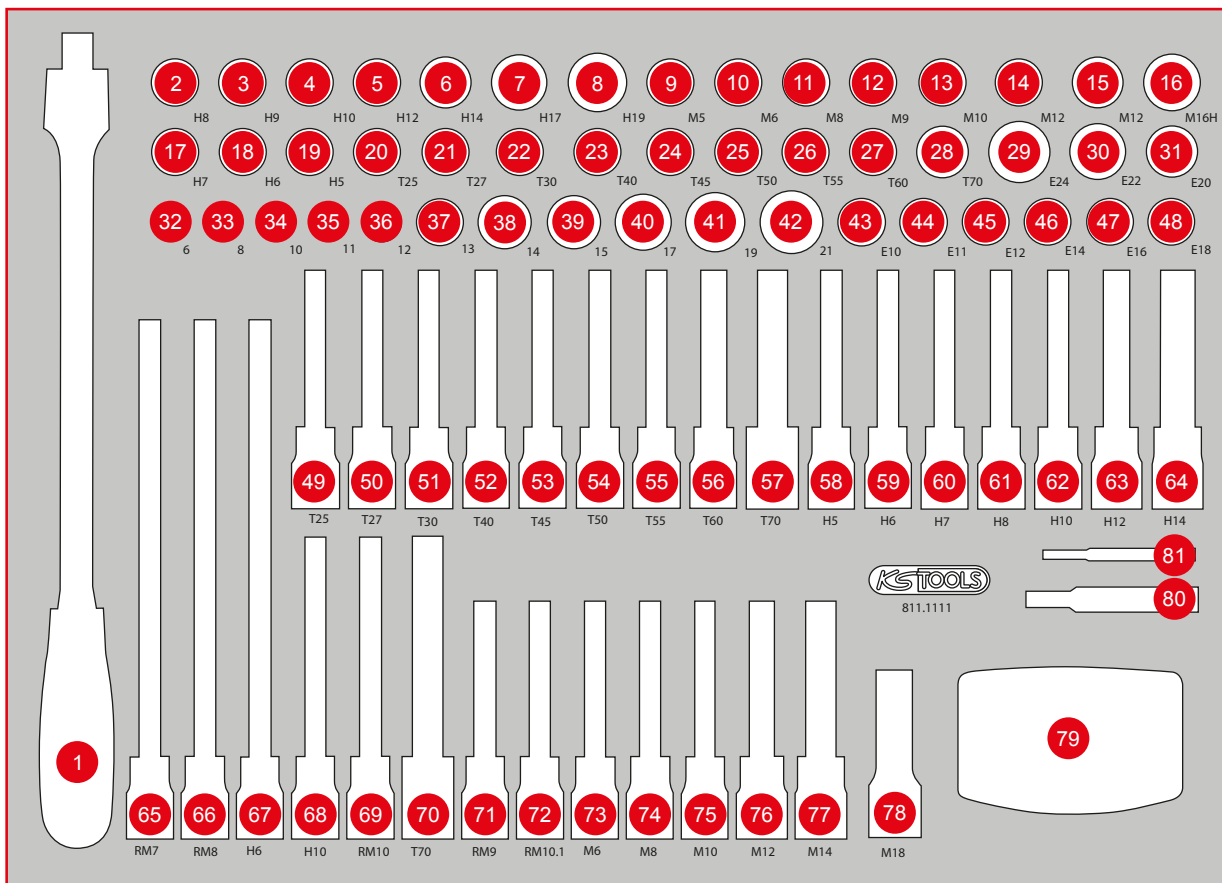

Pos.	Code	Description	pcs	Pos.	Code	Description	pcs	Pos.	Code	Description	pcs
42	913.1463	1/2" Spiral profile impact socket, 21 mm	1	56	911.1529	1/2" Bit socket Torx, long, T60	1	70	911.1942	1/2" Bit socket Torx, T70, 140 mm	1
43	911.4333	1/2" Torx E Socket, E10	1	57	911.1517	1/2" Bit socket Torx, long, T70	1	71	911.1925	1/2" Bit socket RIBE, M9, 110 mm	1
44	911.4334	1/2" Torx E Socket, E11	1	58	911.1325	1/2" Bit socket hexagon, long, 5 mm	1	72	911.4554	1/2" Bit socket RIBE, M10.1, 110 mm	1
45	911.4335	1/2" Torx E Socket, E12	1	59	911.1326	1/2" Bit socket hexagon, long, 6 mm	1	73	911.1351	1/2" Bit socket spline (XZN), M6, 110 mm	1
46	911.4336	1/2" Torx E Socket, E14	1	60	911.1327	1/2" Bit socket hexagon, long, 7 mm	1	74	911.1352	1/2" Bit socket spline (XZN), M8, 110 mm	1
47	911.4322	1/2" Torx E Socket, E16	1	61	911.1328	1/2" Bit socket hexagon, long, 8 mm	1	75	911.1353	1/2" Bit socket spline (XZN), M10, 110 mm	1
48	911.4323	1/2" Torx E Socket, E18	1	62	911.1330	1/2" Bit socket hexagon, long, 10 mm	1	76	911.1354	1/2" Bit socket spline (XZN), M12, 110 mm	1
49	911.1522	1/2" Bit socket Torx, long, T25	1	63	911.1332	1/2" Bit socket hexagon, long, 12 mm	1	77	911.1355	1/2" Bit socket spline (XZN), M14, 110 mm	1
50	911.1523	1/2" Bit socket Torx, long, T27	1	64	917.1332	1/2" Bit socket hexagon, long, 14 mm	1	78	515.1176	1/2" impact socket, XZN, M18 long	1
51	911.1524	1/2" Bit socket Torx, long, T30	1	65	911.1993	1/2" Bit socket RIBE, M7, 240 mm	1	79	911.2055	1/4" Bit set, 31 pcs	1
52	911.1525	1/2" Bit socket Torx, long, T40	1	66	911.1994	1/2" Bit socket RIBE, M8, 240 mm	1	80	913.1475	Extension drive, large	1
53	911.1526	1/2" Bit socket Torx, long, T45	1	67	911.5313	Hex bit socket, ball ended, long, 1/2", 6 mm	1	81	913.1474	Extension drive, small	1
54	911.1527	1/2" Bit socket Torx, long, T50	1	68	911.1960	1/2" Bit socket hexagon, 10 mm, 140 mm	1				
55	911.1528	1/2" Bit socket Torx, long, T55	31	69	911.1980	1/2" Bit socket RIBE, M10, 140 mm	1				

**M** Screw spanner set

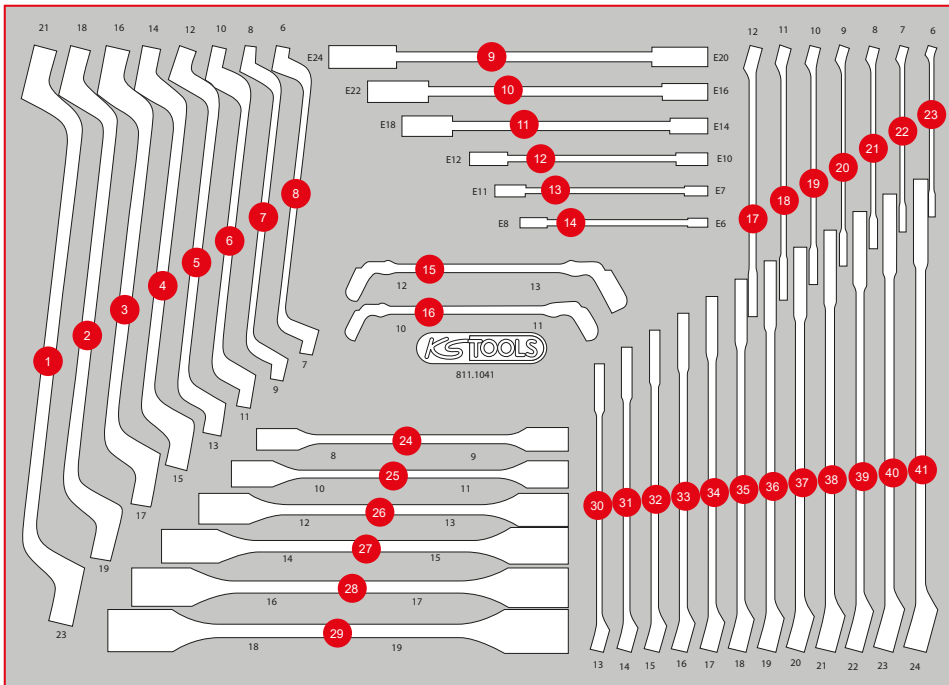

Pos.	Code	Description	pcs
1	517.0815	Double ring spanner, offset, 21 x 23 mm	1
2	517.0812	Double ring spanner, offset, 18 x 19 mm	1
3	517.0810	Double ring spanner, offset, 16 x 17 mm	1
4	517.0809	Double ring spanner, offset, 14 x 15 mm	1
5	517.0807	Double ring spanner, offset, 12 x 13 mm	1
6	517.0804	Double ring spanner, offset, 10 x 11 mm	1
7	517.0802	Double ring spanner, offset, 8 x 9 mm	1
8	517.0801	Double ring spanner, offset, 6 x 7 mm	1
9	911.0376	Double ring spanner for Torx E profile, E20 x E24	1
10	911.0375	Double ring spanner for Torx E profile, E16 x E22	1
11	911.0374	Double ring spanner for Torx E profile, E14 x E18	1
12	911.0373	Double ring spanner for Torx E profile, E10 x E12	1
13	911.0372	Double ring spanner for Torx E profile, E7 x E11	1
14	911.0371	Double ring spanner for Torx E profile, E6 x E8	1
15	518.0529	Open double ring spanner, with double joint, 12 x 13 mm	1
16	518.0528	Open double ring spanner, with double joint, 10 x 11	1
17	517.0612	Combination spanners, offset, 12 mm	1
18	517.0611	Combination spanners, offset, 11 mm	1
19	517.0610	Combination spanners, offset, 10 mm	1
20	517.0609	Combination spanners, offset, 9 mm	1
21	517.0608	Combination spanners, offset, 8 mm	1
22	517.0607	Combination spanners, offset, 7 mm	1
23	517.0606	Combination spanners, offset, 6 mm	1
24	517.0301	Double revolving head spanner, 8 x 9 mm	1
25	517.0302	Double revolving head spanner, 10 x 11 mm	1
26	517.0303	Double revolving head spanner, 12 x 13 mm	1
27	517.0304	Double revolving head spanner, 14 x 15 mm	1
28	517.0305	Double revolving head spanner, 16 x 17 mm	1
29	517.0306	Double revolving head spanner, 18 x 19 mm	1
30	517.0613	Combination spanners, offset, 13 mm	1
31	517.0614	Combination spanners, offset, 14 mm	1
32	517.0615	Combination spanners, offset, 15 mm	1
33	517.0616	Combination spanners, offset, 16 mm	1
34	517.0617	Combination spanners, offset, 17 mm	1
35	517.0618	Combination spanners, offset, 18 mm	1
36	517.0619	Combination spanners, offset, 19 mm	1
37	517.0620	Combination spanners, offset, 20 mm	1
38	517.0621	Combination spanners, offset, 21 mm	1
39	517.0622	Combination spanners, offset, 22 mm	1
40	517.0623	Combination spanners, offset, 23 mm	1
41	517.0624	Combination spanners, offset, 24 mm	1

811.0019

**M** Pliers and file set

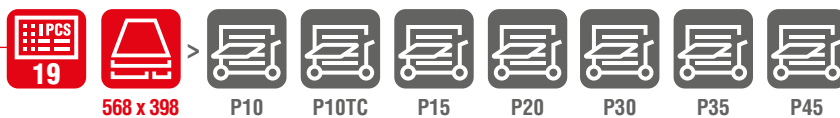

Pos.	Code	Description	pcs
1	157.0405	Tri-bastard file, form C, cut 2, 200 mm	1
2	157.0105	Halfround file, form E, cut 2, 20 mm	1
3	157.0005	Flat file, form B, cut 2, 200 mm	1
4	157.0205	Round file, form F, cut 2, 200 mm	1
5	907.2166	Snap off blades 0,5 x1 8 x 100 mm, dispenser with 10 pieces	10
6	300.0114	Tape measure with locking device and belt clip, black red, 5 m, 19 mm	1
7	300.0510	Pocket vernier calliper 0-150 mm, 235 mm	1
8	300.0600	Feeler gauge, 20 Blades, 0,05-1 mm	1
9	907.2135	Universal snap off blade knife 18 mm	1
10	115.1033	Self grip wrench, 220 mm	1
11	115.2010	Water pump pliers, 240 mm	1
12	500.1026	Circlip pliers for external circlips, angled, 160 mm	1
13	500.1029	Circlip pliers for external circlips, 160 mm	1
14	500.1032	Circlip pliers for internal circlips, angled, 160 mm	1
15	500.1035	Circlip pliers for internal circlips, 160 mm	1
16	115.1012	ERGOTORQUE diagonal side cutter, 160 mm	1
17	115.1021	ERGOTORQUE combination pliers, 180 mm	1
18	115.1019	ERGOTORQUE bent nose pliers serrated, 210 mm	1
19	115.1024	ERGOTORQUE long nose pliers serrated cutter, 200 mm	1

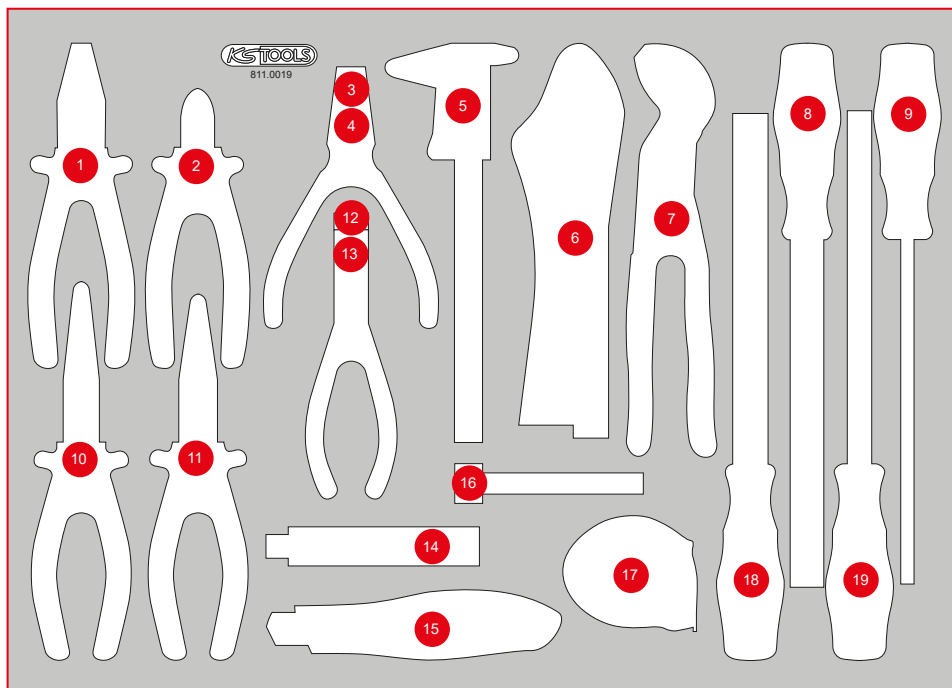

811.0043

**M** Oil and tyre servicing set



Pos.	Code	Description	pcs	Pos.	Code	Description	pcs	Pos.	Code	Description	pcs
1	150.2222	Brake piston reset device, 3/8"	1	8	150.9116	3/8" Oil service bit socket 12 mm for internal square screws	1	14	150.9124	3/8" Oil service bit socket 9 mm for internal square screws	1
2	150.9120	3/8" Oil service bit socket for internal square screws, 3/8" mm	1	9	150.9117	3/8" Oil service bit socket 13 mm for internal square screws	1	15	150.9125	3/8" Oil service bit socket 10 mm for internal square screws	1
3	150.9119	3/8" Oil service bit socket for internal square screws, 5/16" mm	1	10	150.9118	3/8" Oil service bit socket 14 mm for internal square screws	1	16	150.9126	3/8" Oil service bit socket 12 mm for internal square screws	1
4	150.9111	3/8" Oil service bit socket for internal square screws, 7 mm	1	11	150.9122	3/8" Oil service bit socket 10 mm for internal square screws	1	17	150.9127	3/8" Oil service bit socket 14 mm for internal square screws	1
5	150.9112	3/8" Oil service bit socket for internal square screws, 8 mm	1	12	150.9121	3/8" Oil service bit socket 10 mm for internal square screws	1	18	150.9128	3/8" Oil service bit socket 17 mm for internal square screws	1
6	150.9113	3/8" Oil service bit socket for internal square screws, 10 mm	1	13	150.9123	3/8" Oil service bit socket 8 mm for internal square screws	1	19	150.2153	1/2" Brake calliper bit socket, pentagon, 10 mm	1
7	150.9114	3/8" Oil service bit socket for internal square screws, 11 mm	1					20	150.2154	1/2" Brake calliper socket, pentagon, 14 mm	1

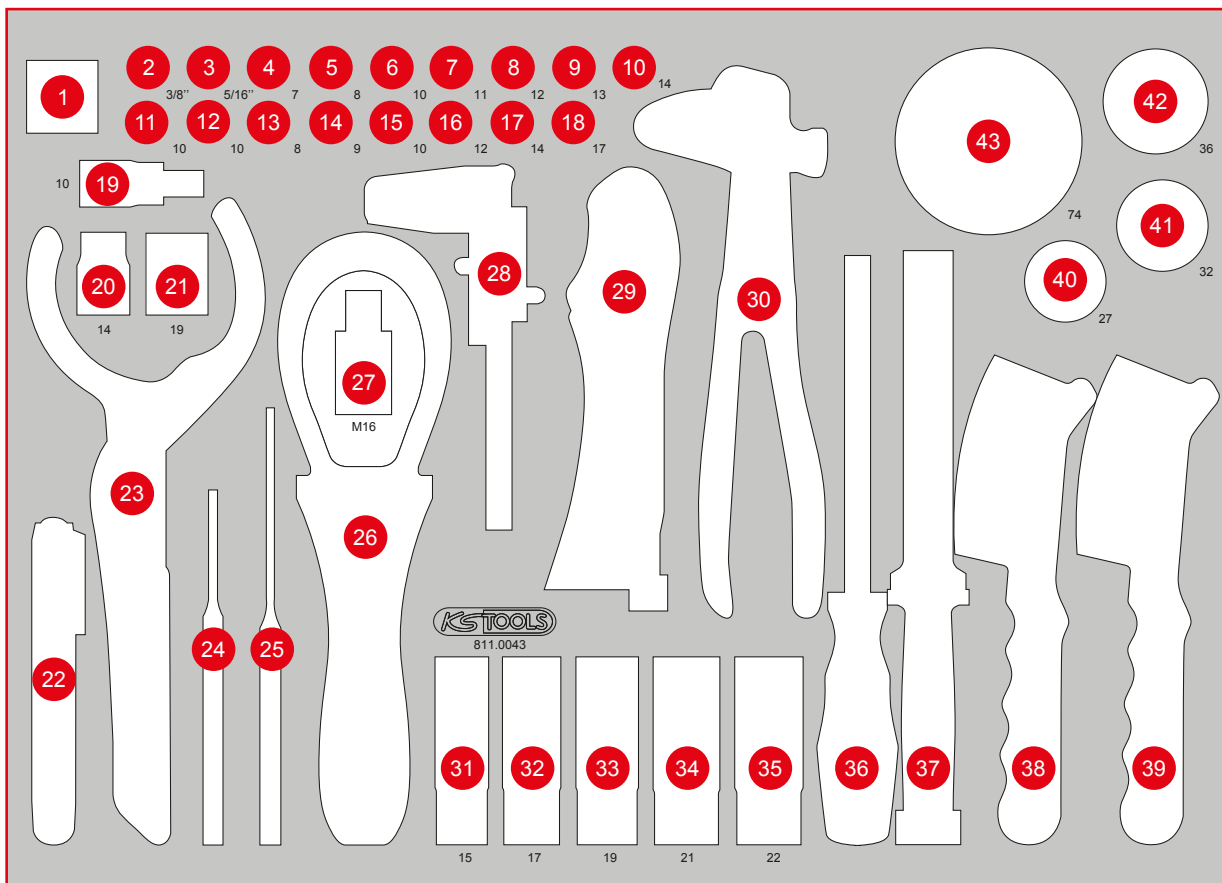

Pos.	Code	Description	pcs	Pos.	Code	Description	pcs	Pos.	Code	Description	pcs
21	150.2155	1/2" Brake calliper socket, pentagon, 19 mm	1	29	115.1175	Round jaw-American type, 175 mm	1	35	515.0995	SlimPOWER 1/2" Alloy rim impact socket, 22 mm	1
22	150.2199	Brake fluid tester	1	30	150.2025	Wheel balance weight pliers, 250 mm	1	36	157.0960	Brake saddle file, extra narrow, 270 mm	1
23	150.9317	Oil filter pliers, 50-125 mm	1	31	515.0991	SlimPOWER 1/2" Alloy rim impact socket, 15 mm	1	37	911.8132	Glass fibre chisel, 22 mm	1
24	156.0114	Pin punch octagonal shaft, mirror polished, Ø 5 mm	1	32	515.0992	SlimPOWER 1/2" Alloy rim impact socket, 17 mm	1	38	201.2335	Steel wire brake saddle brush, 2-row, straight	1
25	156.0122	Pin punch octagonal shaft, mirror polished, extra long, Ø 4 mm	1	33	515.0993	SlimPOWER 1/2" Alloy rim impact socket, 19 mm	1	39	201.2340	Brass wire brake saddle brush, 2-row, curved	1
26	155.5005	Oil filter band wrench, Ø 65-105 mm	1	34	515.0994	SlimPOWER 1/2" Alloy rim impact socket, 21 mm	1	40	150.9217	3/8" Universal Oil filter band wrench, SW 27 mm	1
27	911.1348	1/2" Bit socket spline (XZN) tamperproof, M16, 55 mm	1					41	150.9218	3/8" Universal Oil filter band wrench, SW 32 mm	1
28	300.0535	Brake disk vernier calliper, 0-60 mm, 162 mm	1					42	150.9219	3/8" Universal Oil filter band wrench, SW 36 mm	1
								43	150.9215	3/8" Oil filter wrench, 74,2 mm, 14 grooves	1

**M** Hammer and chisel set



Pos.	Code	Description	pcs
1	911.8138	Trim plastic wedge, 195 x 30 mm	1
2	140.5252	Recoil free soft faced Hammer, 400 g	1
3	142.1402	Fitters Hammer, fiberglas handle, 400 g	1
4	142.5101	Club Hammer, fiberglas handle, 1000 g	1
5	550.1025	Flexible magnet lifter, 510 mm, Øhead=15 mm	1
6	550.1001	2in1 Telescopic solenoid holder with washer jet cleaning and setting tool, 150 - 675 mm	1
7	150.4370	perfectLight torch 85 lumen	1
8	911.8146	Tyre lever, 370 mm	1
9	201.2335	Steel wire brake saddle brush, 2-row, straight 225 mm	1
10	156.0241	Flat chisel, octagon, 20 mm	1
11	156.0254	Flat chisel, octagon, 18 mm	1
12	156.0242	Cross chisel, octagon, 7 mm	1
13	156.0243	Centre punch, octagon 10 mm	1
14	156.0244	Punch, Ø 5 mm, conical	1
15	156.0238	Punch, Ø 4 mm, conical	1
16	156.0237	Punch, Ø 3 mm, conical	1
17	156.0231	Pin punch, Ø 3 mm, cylindrical shaft	1
18	156.0232	Pin punch, Ø 4 mm, cylindrical shaft	1
19	156.0233	Pin punch, Ø 5 mm, cylindrical shaft	1
20	156.0234	Pin punch, Ø 6 mm, cylindrical shaft	1
21	156.0235	Pin punch, Ø 8 mm, cylindrical shaft	1
22	907.2232	Gasket scraper, 25 x 200 mm	1

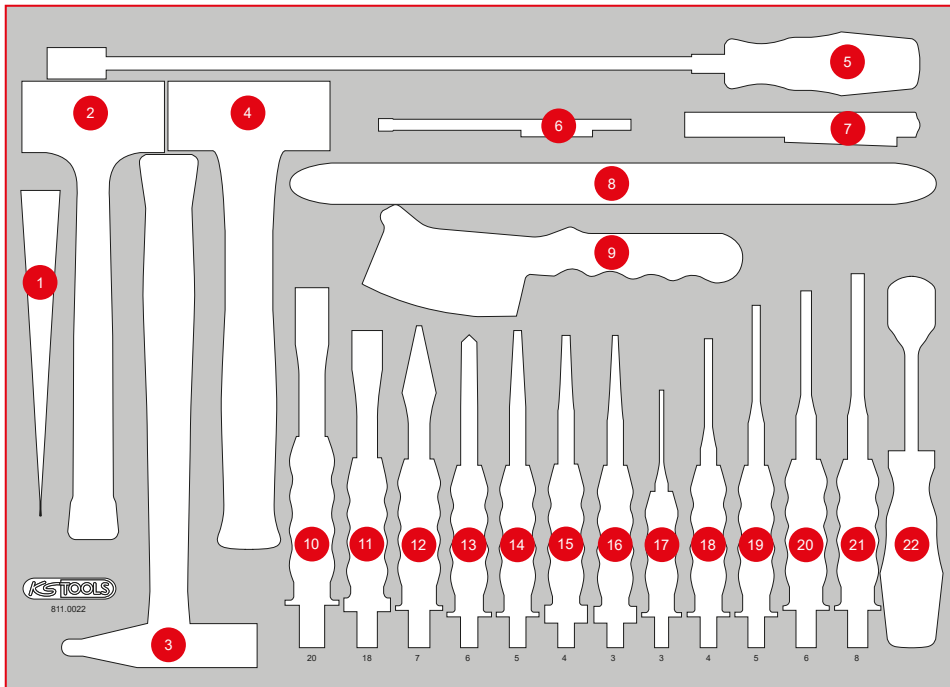

# P10

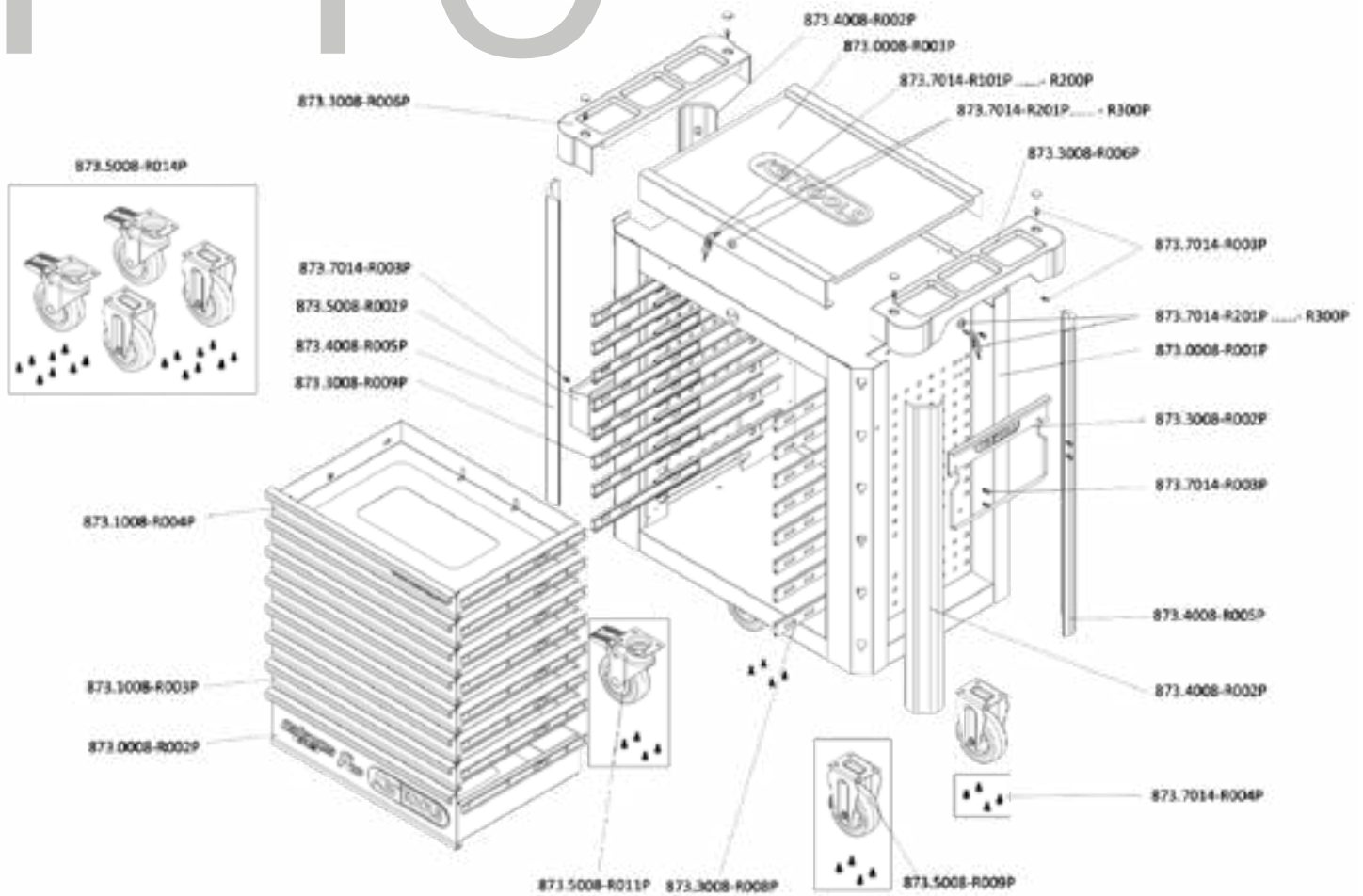

## INDIVIDUAL PARTS LIST

Item No.	Description	Amount
873.7014-R101P...	Replacement key for PERFORMANCEplus workshop trolley lock number xyz	2
873.7014-R201P...	Lock with 2 keys for PERFORMANCEplus workshop trolley lock number xyz	2
873.0008-R001P	Body with handle	1
873.0008-R002P	Compartment with logo and ball-bearing guide, 568x398x145 mm	1
873.0008-R003P	Stainless steel worktop	1
873.1008-R003P	Compartment with ball-bearing guide, for workshop trolley P10/P10TC/P15, 568x398x65 mm	6
873.1008-R004P	Compartment with website and ball-bearing guide, for workshop trolley P10/P15, 568x398x65 mm	1
873.3008-R002P	Paper roll holder for PERFORMANCEplus workshop trolley	1
873.3008-R006P	Storage for work surface	2
873.3008-R008P	Full extension (with ball-bearing guide) with automatic retraction	8
873.3008-R009P	Full extension (with ball-bearing guide) with automatic retraction	8
873.4008-R002P	Plastic bumpers	2
873.4008-R005P	Plastic bumpers	2
873.5008-R002P	Can holder for PERFORMANCEplus workshop trolley	1
873.5008-R009P	Fixed castors for PERFORMANCEplus workshop trolley, incl. screws	2
873.5008-R011P	Swivel castors with brakes, for PERFORMANCEplus workshop trolley, incl. screws	2
873.5008-R014P	Roller set for PERFORMANCEplus workshop trolley, incl. screws	1
873.7014-R003P	M6x12 screws for PERFORMANCEplus workshop trolley accessories	14
873.7014-R004P	M8 screws for PERFORMANCEplus workshop trolley rollers (16 pcs.)	1



**873.7014-R101P...R200P**  
Replacement key for lock number xyz



**873.7014-R201P...R300P**  
Lock with 2 keys for lock number xyz



**873.3008-R008P**  
Full extension (with ball-bearing guide) with automatic retraction, right



**873.3008-R009P**  
Full extension (with ball-bearing guide) with automatic retraction, left



**873.5008-R009P**  
Fixed castors, incl. screws



**873.5008-R011P**  
Swivel castors with brakes, incl. screws

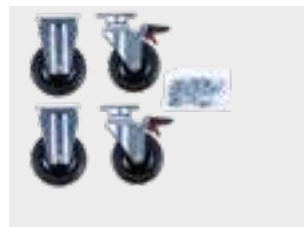

**873.5008-R014P**  
Roller set, incl. screws



**873.0008-R003P**  
Stainless steel work surface



**873.3008-R006P**  
Storage for work surface, including screw cover, usable on both sides



**873.1008-R004P**  
Compartment with website and ball-bearing guide, 568x398x65 mm



**873.1008-R003P**  
Compartment with ball-bearing guide, 568x398x65 mm



**873.0008-R002P**  
Compartment with logo and ball-bearing guide, 568x398x145 mm



**873.5008-R002P**  
Can holder, 310 mm



**873.3008-R002P**  
Paper roll holder, 320 mm



**873.4008-R005P**  
Plastic bumpers, front left, back right



**873.4008-R002P**  
Plastic bumpers, front right, back left



**873.7014-R004P**  
M8 screws (16 pcs.)



**873.7014-R003P**  
M6x12 screw (1 pcs.)



**873.0008-R001P**  
Body with handle



A thousand great parts for tough guys!

