

# P15

**workshop tool trolley**  
with 397 tools for 7 drawers  
**815.7397**

# THE COMPACT HEAVYWEIGHT

P15



**Workshop trolley P15**  
with 8 compartments  
873.1008



**DUO Lock** Brilliant locking system



**Eight drawers** each load capacity up to 50 kg



Stable **ball bearing**



**Plastic Surface**

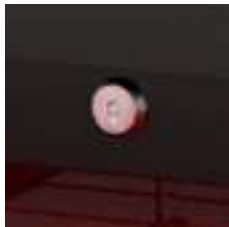

**Lock** lockable



**Anti-static castors** with brakes



Integrated **corner protection**



**Paper roll holder** included



**Can holder** included

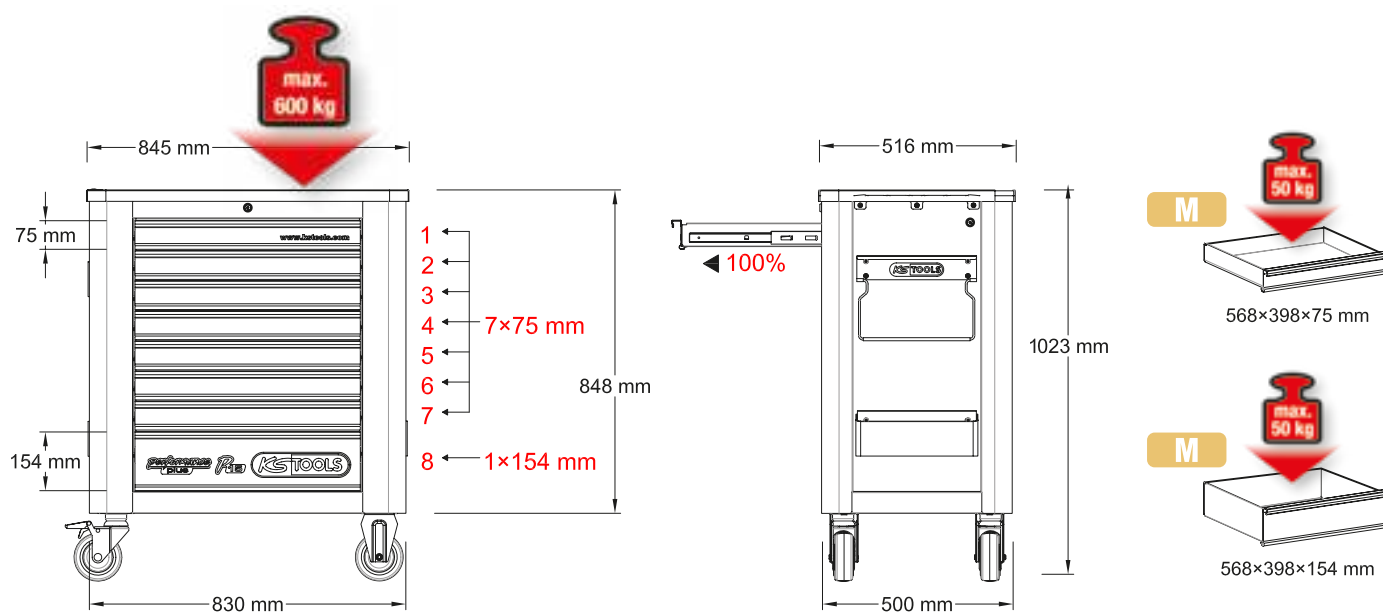

# P15 workshop tool trolley set with 397 tools for 7 drawers

815.7397



IPCS  
397

M



Screw spanner set in foam insert

811.0041

IPCS  
41



1/4" + 3/8" + 1/2" socket spanner set in foam insert

811.0111

IPCS  
111

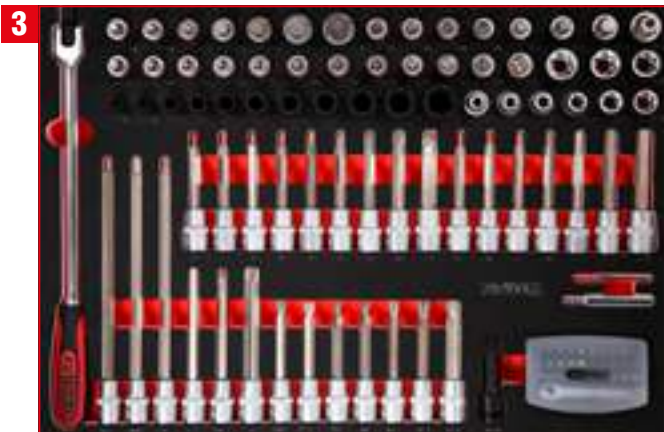

3

1/2" screwdriver bit set  
in foam insert

811.1111



4

5

Screw spanner set in  
foam insert

811.1041



Pliers and file set in foam  
insert

811.0019



6

7

Oil and tyre servicing set  
in foam insert

811.0043



Hammer and chisel set in  
foam insert

811.0022



P 10

P 15

P 20

P 25

P 30

P 35

P 40

P 45

Single inserts

Individual parts

Accessories

**M** Screwdriver set

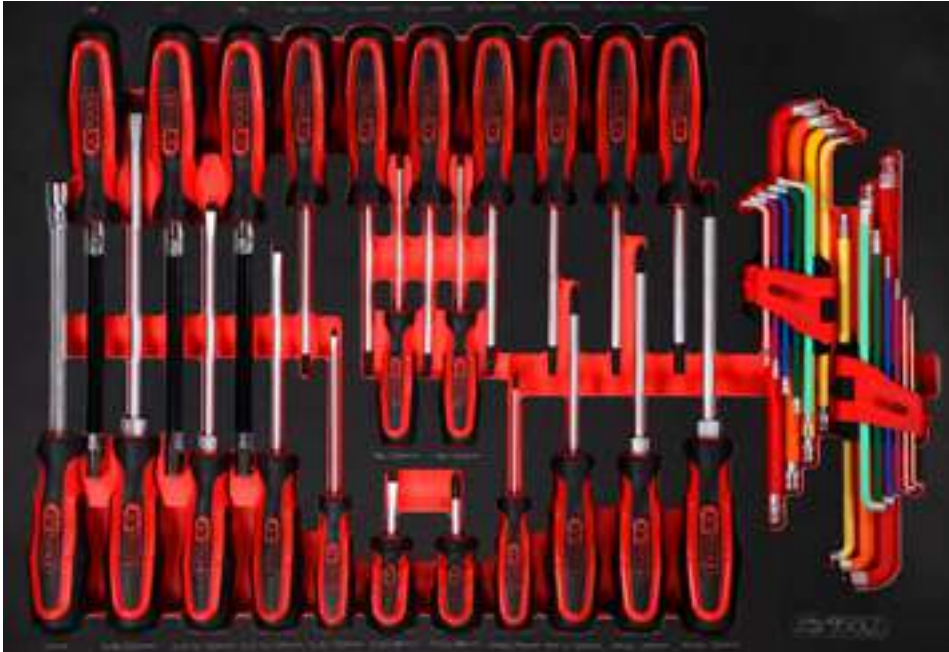

Pos.	Code	Description	pcs
1	911.1128	ERGOTORQUE Socket screwdriver, 8 mm	1
2	159.1127	ERGOTORQUEplus Socket screwdriver, 7 mm	1
3	159.1126	ERGOTORQUEplus Socket screwdriver, 6 mm	1
4	159.1032	ERGOTORQUEplus screwdriver, Torx, T10	1
5	159.1033	ERGOTORQUEplus screwdriver, Torx, T15	1
6	159.1034	ERGOTORQUEplus screwdriver, Torx, T20	1
7	159.1035	ERGOTORQUEplus screwdriver, Torx, T25	1
8	159.1036	ERGOTORQUEplus screwdriver, Torx, T27	1
9	159.1037	ERGOTORQUEplus screwdriver, Torx, T30	1
10	159.1038	ERGOTORQUEplus screwdriver, Torx, T40	1
11	159.1208	ERGOTORQUEplus socket screwdriver, 10 mm	1
12	159.1011	ERGOTORQUEplus screwdriver for slotted screws, 8 mm, 315 mm	1
13	159.1009	ERGOTORQUEplus screwdriver for slotted screws, 6,5 mm, 255 mm	1
14	159.1006	ERGOTORQUEplus screwdriver for slotted screws, 5,5 mm, 230 mm	1
15	159.1004	ERGOTORQUEplus screwdriver for slotted screws, 4 mm, 180 mm	1
16	159.1030	ERGOTORQUEplus screwdriver, Torx, T8	1
17	159.1031	ERGOTORQUEplus screwdriver, Torx, T9	1
18	159.1001	ERGOTORQUEplus screwdriver for slotted screws, 6 mm, stubby	1
19	159.1026	ERGOTORQUEplus screwdriver for screws PH, PH2, stubby	1
20	159.1027	ERGOTORQUEplus screwdriver for screws PH, PH0, 155 mm	1
21	159.1029	ERGOTORQUEplus screwdriver for screws PH, PH1, 205 mm	1
22	159.1022	ERGOTORQUEplus screwdriver for screws PH, PH2, 230 mm	1
23	159.1024	ERGOTORQUEplus screwdriver for screws PH, PH3, 265 mm	1
24	151.4530	Ball ended Torx key wrench set, extra long and bent 108°, 9 pcs	9
25	151.4560	Ball ended hexagon key wrench set, 108° angled, 9 pcs	9

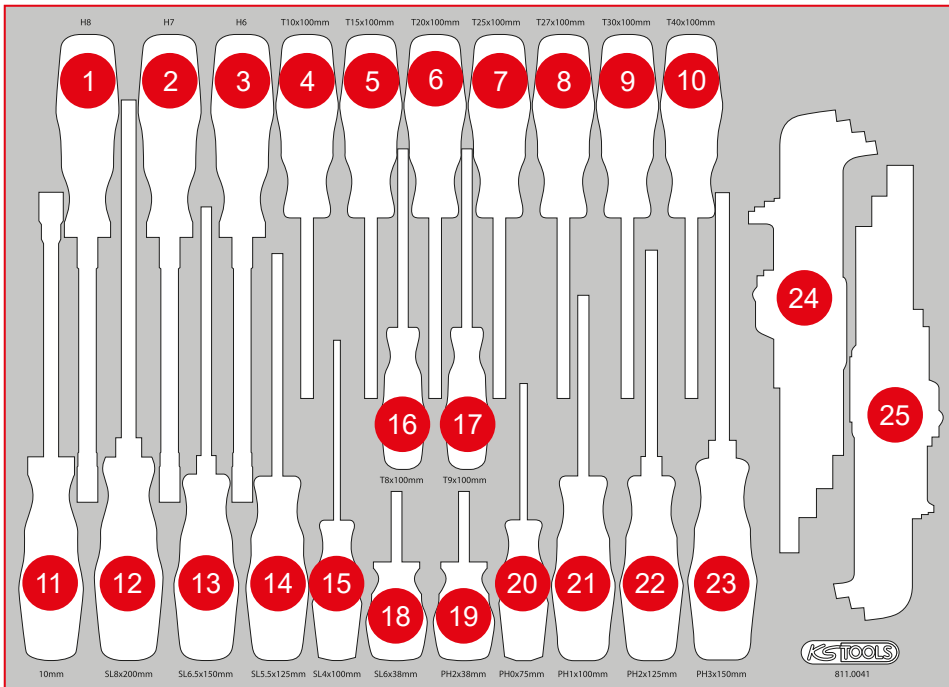

**M** 1/4" + 3/8" + 1/2" Socket spanner set

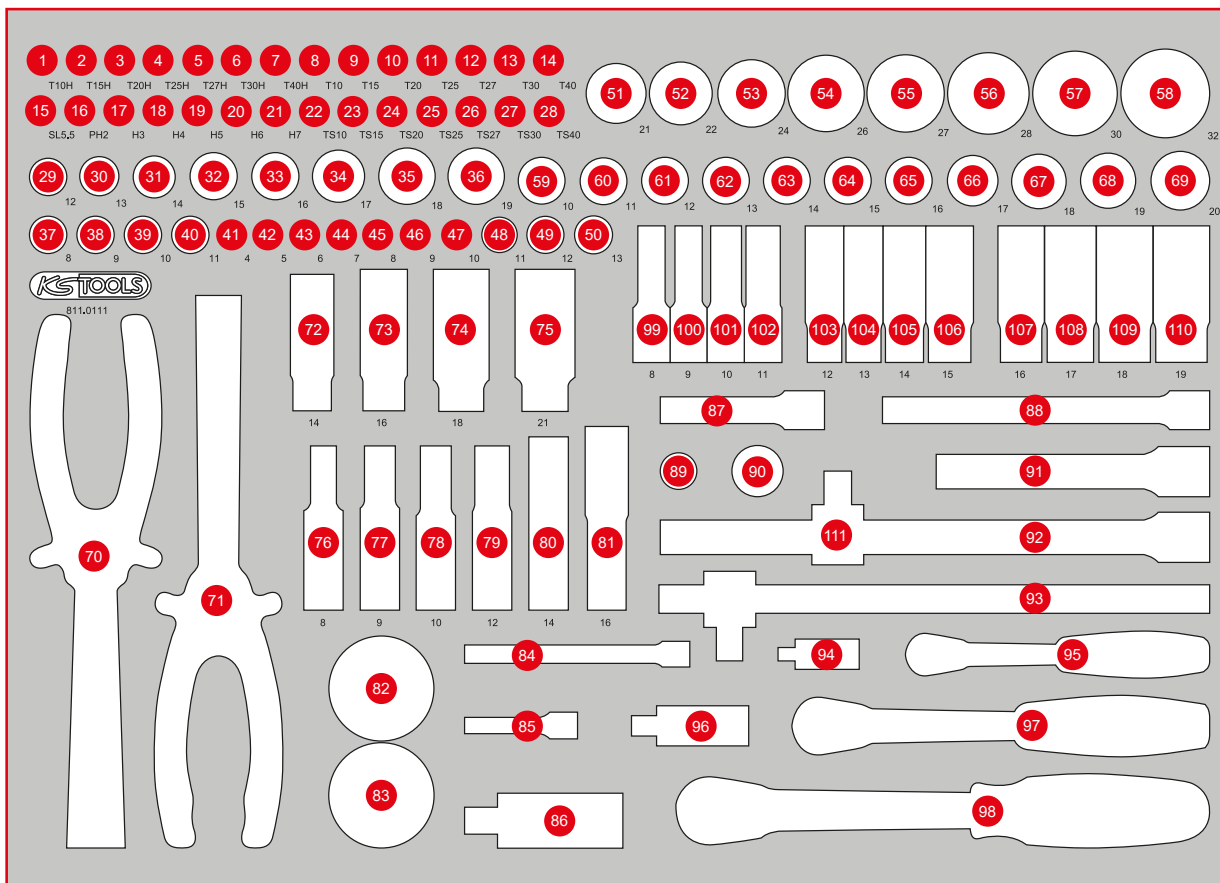

Pos.	Code	Description	pcs	Pos.	Code	Description	pcs	Pos.	Code	Description	pcs
1	911.1462	1/4" Bit socket Torx tamperproof, TB10	1	21	911.1440	1/4" Bit socket hexagon, 7 mm	1	41	917.1404	1/4" Hexagonal socket, 4 mm	1
2	911.1463	1/4" Bit socket Torx tamperproof, TB15	1	22	911.1701	1/4" Bit socket five star tamperproof, TS10	1	42	917.1405	1/4" Hexagonal socket, 5 mm	1
3	911.1464	1/4" Bit socket Torx tamperproof, TB20	1	23	911.1702	1/4" Bit socket five star tamperproof, TS15	1	43	917.1406	1/4" Hexagonal socket, 6 mm	1
4	911.1465	1/4" Bit socket Torx tamperproof, TB25	1	24	911.1703	1/4" Bit socket five star tamperproof, TS20	1	44	917.1407	1/4" Hexagonal socket, 7 mm	1
5	911.1466	1/4" Bit socket Torx tamperproof, TB27	1	25	911.1704	1/4" Bit socket five star tamperproof, TS25	1	45	917.1408	1/4" Hexagonal socket, 8 mm	1
6	911.1467	1/4" Bit socket Torx tamperproof, TB30	1	26	911.1705	1/4" Bit socket five star tamperproof, TS27	1	46	917.1409	1/4" Hexagonal socket, 9 mm	1
7	911.1468	1/4" Bit socket Torx tamperproof, TB40	1	27	911.1706	1/4" Bit socket five star tamperproof, TS30	1	47	917.1410	1/4" Hexagonal socket, 10 mm	1
8	911.1442	1/4" Bit socket Torx, T10	1	28	911.1707	1/4" Bit socket five star tamperproof, TS40	1	48	917.1411	1/4" Hexagonal socket, 11 mm	1
9	911.1443	1/4" Bit socket Torx, T15	1	29	917.3812	3/8" Hexagonal socket, 12 mm	1	49	917.1412	1/4" Hexagonal socket, 12 mm	1
10	911.1444	1/4" Bit socket Torx, T20	1	30	917.3813	3/8" Hexagonal socket, 13 mm	1	50	917.1413	1/4" Hexagonal socket, 13 mm	1
11	911.1445	1/4" Bit socket Torx, T25	1	31	917.3814	3/8" Hexagonal socket, 14 mm	1	51	917.1221	1/2" Hexagonal socket, 21 mm	1
12	911.1449	1/4" Bit socket Torx, T27	1	32	917.3815	3/8" Hexagonal socket, 15 mm	1	52	917.1222	1/2" Hexagonal socket, 22 mm	1
13	911.1446	1/4" Bit socket Torx, T30	1	33	917.3816	3/8" Hexagonal socket, 16 mm	1	53	917.1224	1/2" Hexagonal socket, 24 mm	1
14	911.1447	1/4" Bit socket Torx, T40	1	34	917.3817	3/8" Hexagonal socket, 17 mm	1	54	917.1343	1/2" Hexagonal socket, 26 mm	1
15	911.1419	1/4" Bit socket slot, 5,5 mm	1	35	917.3818	3/8" Hexagonal socket, 18 mm	1	55	917.1227	1/2" Hexagonal socket, 27 mm	1
16	911.1416	1/4" Bit socket, PH2	1	36	917.3819	3/8" Hexagonal socket, 19 mm	1	56	917.1344	1/2" Hexagonal socket, 28 mm	1
17	911.1436	1/4" Bit socket hexagon, 3 mm	1	37	917.3808	3/8" Hexagonal socket, 8 mm	1	57	917.1230	1/2" Hexagonal socket, 30 mm	1
18	911.1437	1/4" Bit socket hexagon, 4 mm	1	38	917.3809	3/8" Hexagonal socket, 9 mm	1	58	917.1232	1/2" Hexagonal socket, 32 mm	1
19	911.1438	1/4" Bit socket hexagon, 5 mm	1	39	917.3810	3/8" Hexagonal socket, 10 mm	1	59	917.1210	1/2" Hexagonal socket, 10 mm	1
20	911.1439	1/4" Bit socket hexagon, 6 mm	1	40	917.3811	3/8" Hexagonal socket, 11 mm	1	60	917.1211	1/2" Hexagonal socket, 11 mm	1



Pos.	Code	Description	pcs	Pos.	Code	Description	pcs	Pos.	Code	Description	pcs
61	917.1212	1/2" Hexagonal socket, 12 mm	1	79	500.7304	3/8" Glow plug joint sockets, short, 75 mm, 12 mm	1	96	911.3850	3/8" Universal joint	1
62	917.1213	1/2" Hexagonal socket, 13 mm	1	80	500.7305	3/8" Glow plug joint sockets, short, 75 mm, 14 mm	1	97	920.3890	3/8" SlimPOWER Reversible ratchet, 72 teeth	1
63	917.1214	1/2" Hexagonal socket, 14 mm	1	81	500.7306	3/8" Glow plug joint sockets, short, 75 mm, 16 mm	1	98	920.1290	1/2" SlimPOWER Reversible ratchet, 72 teeth	1
64	917.1215	1/2" Hexagonal socket, 15 mm	1	82	914.1410	Mini hand reversible ratchet, 1/4", 72 teethh	1	99	917.3828	3/8" Hexagonal socket, deep, 8 mm	1
65	917.1216	1/2" Hexagonal socket, 16 mm	1	83	914.3810	Mini hand reversible ratchet, 3/8", 72 teethh	1	100	917.3829	3/8" Hexagonal socket, deep, 9 mm	1
66	917.1217	1/2" Hexagonal socket, 17 mm	1	84	911.1424	1/4" Extension with hexagon drive, 100 mm	1	101	917.3830	3/8" Hexagonal socket, deep, 10 mm	1
67	917.1218	1/2" Hexagonal socket, 18 mm	1	85	911.1423	1/4" Extension with hexagon drive, 50 mm	1	102	917.3831	3/8" Hexagonal socket, deep, 11 mm	1
68	917.1219	1/2" Hexagonal socket, 19 mm	1	86	911.1250	1/2" Universal joint	1	103	917.3832	3/8" Hexagonal socket, deep, 12 mm	1
69	917.1220	1/2" Hexagonal socket, 20 mm	1	87	911.3801	3/8" Extension with knurling, 75 mm	1	104	917.3833	3/8" Hexagonal socket, deep, 13 mm	1
70	500.7310	Glow plug pliers, angled, 235 mm	1	88	911.3802	3/8" Extension with knurling, 150 mm	1	105	917.3834	3/8" Hexagonal socket, deep, 14 mm	1
71	500.7330	Glow plug pliers, 265 mm	1	89	911.3897	3/8" Reducing adaptor, 3/8" F x 1/4" M	1	106	917.3835	3/8" Hexagonal socket, deep, 15 mm	1
72	911.3990	3/8" Special spark plug socket, thin-walled, 14 mm	1	90	911.3826	3/8" Slider/Reducing adaptor, 1/2" F x 3/8" M	1	107	917.3836	3/8" Hexagonal socket, deep, 16 mm	1
73	911.3804	3/8" Spark plug socket, 16 mm	1	91	911.1202	1/2" Extensions, 125 mm	1	108	917.3837	3/8" Hexagonal socket, deep, 17 mm	1
74	911.3823	3/8" Spark plug socket, 18 mm	1	92	911.1203	1/2" Extensions, 250 mm	1	109	917.3838	3/8" Hexagonal socket, deep, 18 mm	1
75	911.3805	3/8" Spark plug socket, 21 mm	1	93	911.1204	Sliding T-bar, 1/2", 250 mm	1	110	917.3839	3/8" Hexagonal socket, deep, 19 mm	1
76	500.7301	3/8" Glow plug joint sockets, short, 75 mm, 8 mm	1	94	911.1450	1/4" Universal joint	1	111	911.1207	3/8" Sliding adaptor, 3/8" F x 1/2" M	1
77	500.7302	3/8" Glow plug joint sockets, short, 75 mm, 9 mm	1	95	920.1490	1/4" SlimPOWER Reversible ratchet, 72 teeth	1				
78	500.7303	3/8" Glow plug joint sockets, short, 75 mm, 10 mm	1								

811.1111

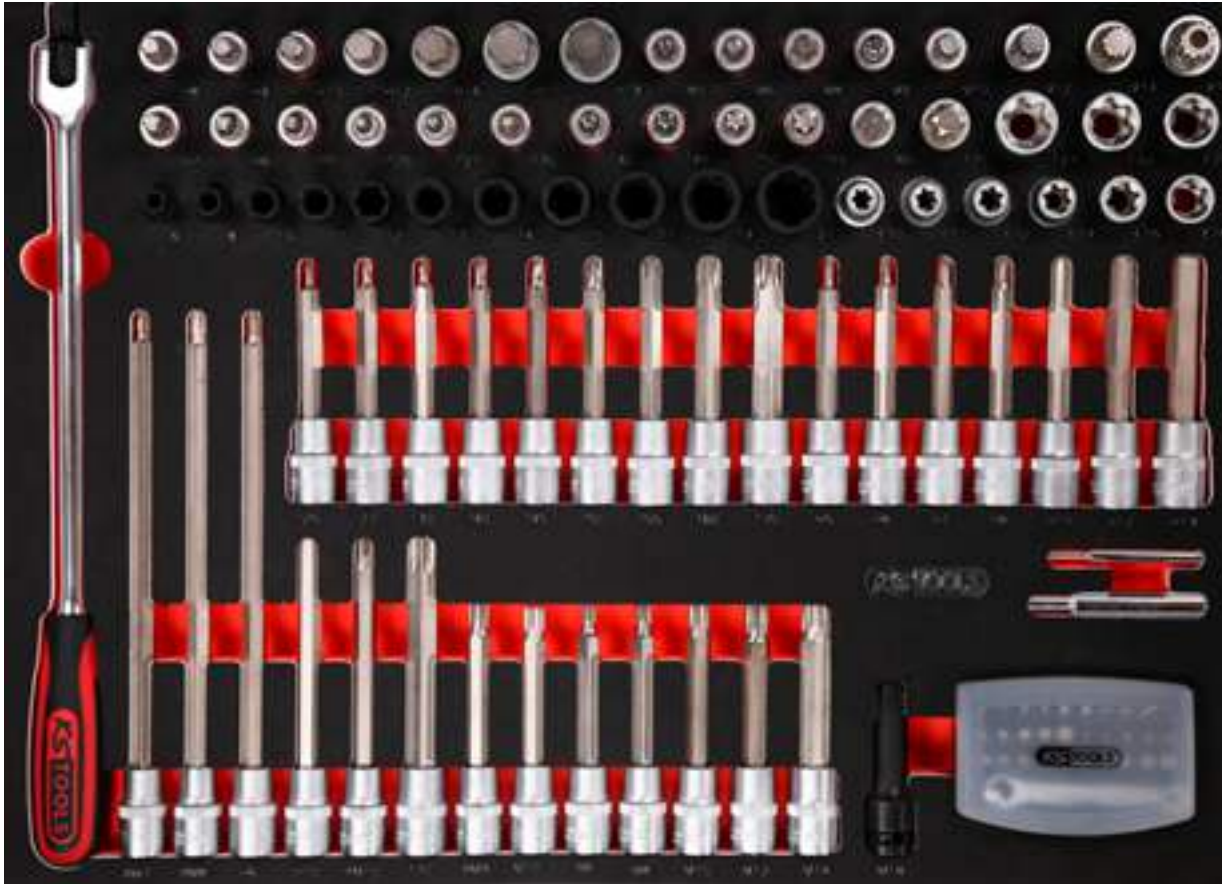
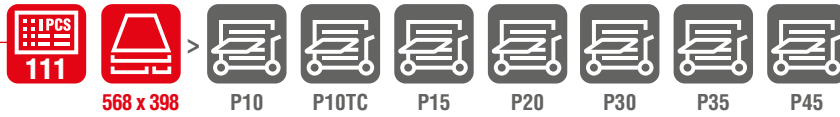
**M** 1/2" Screwdriver bit set



Pos.	Code	Description	pcs	Pos.	Code	Description	pcs	Pos.	Code	Description	pcs
1	917.1455	1/2" Flexi head drive handle	1	15	911.1345	1/2" Bit socket spline (XZN), M14, 55 mm	1	28	911.1370	1/2" Bit socket Torx, T70	1
2	911.1308	1/2" Bit socket hexagon, short, 8 mm	1	16	911.1348	1/2" Bit socket spline (XZN) tamperproof, M16, 55 mm	1	29	911.4326	1/2" Torx E Socket, E24	1
3	911.1309	1/2" Bit socket hexagon, short, 9 mm	1	17	911.1307	1/2" Bit socket hexagon, short, 7 mm	1	30	911.4325	1/2" Torx E Socket, E22	1
4	911.1310	1/2" Bit socket hexagon, short, 10 mm	1	18	911.1306	1/2" Bit socket hexagon, short, 6 mm	1	31	911.4324	1/2" Torx E Socket, E20	1
5	911.1312	1/2" Bit socket hexagon, short, 12 mm	1	19	911.1305	1/2" Bit socket hexagon, short, 5 mm	1	32	913.1473	1/4" Spiral profile impact socket, 6 mm	1
6	911.1314	1/2" Bit socket hexagon, short, 14 mm	1	20	911.1362	1/2" Bit socket Torx, T25	1	33	913.1408	1/4" Spiral profile impact socket, 8 mm	1
7	911.1317	1/2" Bit socket hexagon, short, 17 mm	1	21	911.1363	1/2" Bit socket Torx, T27	1	34	913.1410	1/4" Spiral profile impact socket, 10 mm	1
8	911.1319	1/2" Bit socket hexagon, short, 19 mm	1	22	911.1364	1/2" Bit socket Torx, T30	1	35	913.1470	1/4" Spiral profile impact socket, 11 mm	1
9	911.1340	1/2" Bit socket spline (XZN), M5, 55 mm	1	23	911.1365	1/2" Bit socket Torx, T40	1	36	913.1412	1/4" Spiral profile impact socket, 12 mm	1
10	911.1341	1/2" Bit socket spline (XZN), M6, 55 mm	1	24	911.1366	1/2" Bit socket Torx, T45	1	37	913.1468	1/2" Spiral profile impact socket, 13 mm	1
11	911.1342	1/2" Bit socket spline (XZN), M8, 55 mm	1	25	911.1367	1/2" Bit socket Torx, T50	1	38	913.1467	1/2" Spiral profile impact socket, 14 mm	1
12	911.1313	1/2" Bit socket spline (XZN), M9, 55 mm	1	26	911.1368	1/2" Bit socket Torx, T55	1	39	913.1466	1/2" Spiral profile impact socket, 15 mm	1
13	911.1343	1/2" Bit socket spline (XZN), M10, 55 mm	1	27	911.1369	1/2" Bit socket Torx, T60	1	40	913.1465	1/2" Spiral profile impact socket, 17 mm	1
14	911.1344	1/2" Bit socket spline (XZN), M12, 55 mm	1					41	913.1464	1/2" Spiral profile impact socket, 19 mm	1

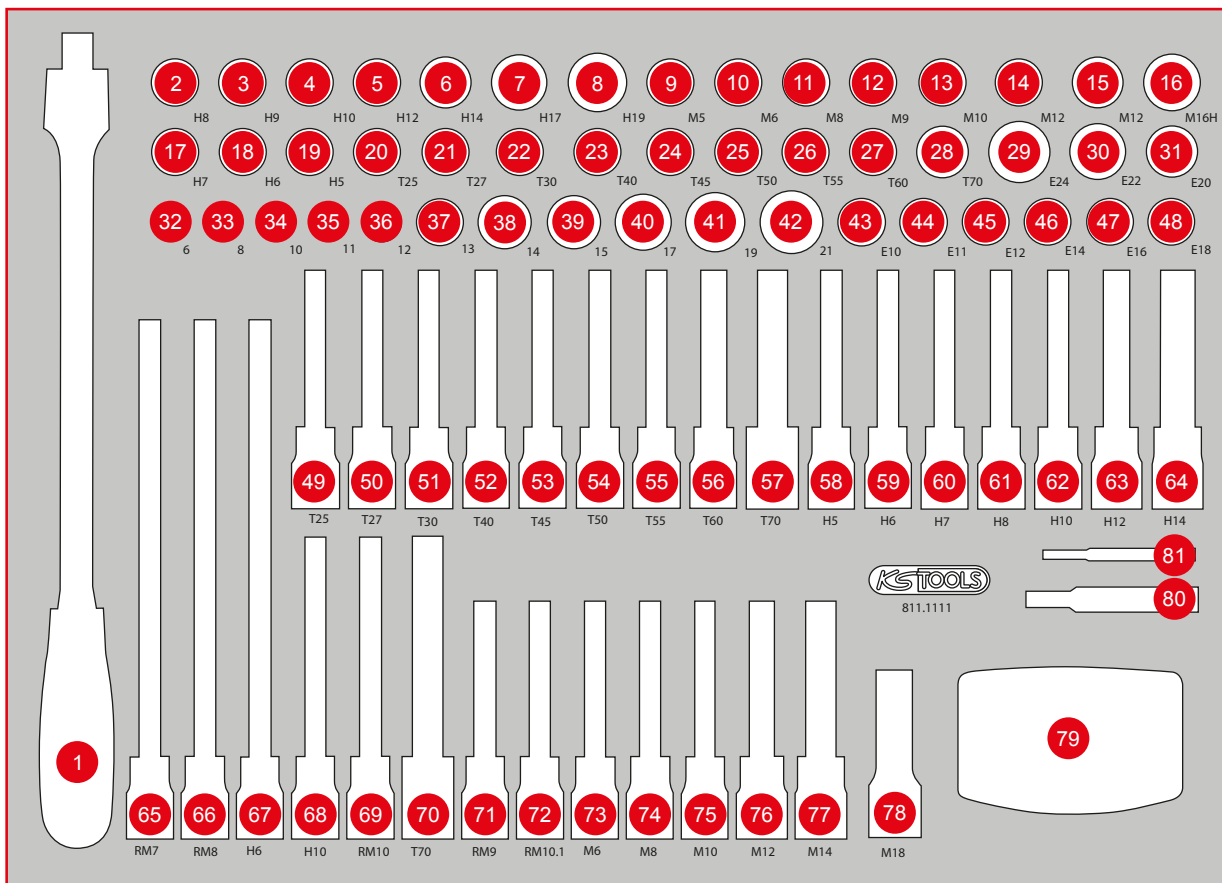

Pos.	Code	Description	pcs	Pos.	Code	Description	pcs	Pos.	Code	Description	pcs
42	913.1463	1/2" Spiral profile impact socket, 21 mm	1	56	911.1529	1/2" Bit socket Torx, long, T60	1	70	911.1942	1/2" Bit socket Torx, T70, 140 mm	1
43	911.4333	1/2" Torx E Socket, E10	1	57	911.1517	1/2" Bit socket Torx, long, T70	1	71	911.1925	1/2" Bit socket RIBE, M9, 110 mm	1
44	911.4334	1/2" Torx E Socket, E11	1	58	911.1325	1/2" Bit socket hexagon, long, 5 mm	1	72	911.4554	1/2" Bit socket RIBE, M10.1, 110 mm	1
45	911.4335	1/2" Torx E Socket, E12	1	59	911.1326	1/2" Bit socket hexagon, long, 6 mm	1	73	911.1351	1/2" Bit socket spline (XZN), M6, 110 mm	1
46	911.4336	1/2" Torx E Socket, E14	1	60	911.1327	1/2" Bit socket hexagon, long, 7 mm	1	74	911.1352	1/2" Bit socket spline (XZN), M8, 110 mm	1
47	911.4322	1/2" Torx E Socket, E16	1	61	911.1328	1/2" Bit socket hexagon, long, 8 mm	1	75	911.1353	1/2" Bit socket spline (XZN), M10, 110 mm	1
48	911.4323	1/2" Torx E Socket, E18	1	62	911.1330	1/2" Bit socket hexagon, long, 10 mm	1	76	911.1354	1/2" Bit socket spline (XZN), M12, 110 mm	1
49	911.1522	1/2" Bit socket Torx, long, T25	1	63	911.1332	1/2" Bit socket hexagon, long, 12 mm	1	77	911.1355	1/2" Bit socket spline (XZN), M14, 110 mm	1
50	911.1523	1/2" Bit socket Torx, long, T27	1	64	917.1332	1/2" Bit socket hexagon, long, 14 mm	1	78	515.1176	1/2" impact socket, XZN, M18 long	1
51	911.1524	1/2" Bit socket Torx, long, T30	1	65	911.1993	1/2" Bit socket RIBE, M7, 240 mm	1	79	911.2055	1/4" Bit set, 31 pcs	1
52	911.1525	1/2" Bit socket Torx, long, T40	1	66	911.1994	1/2" Bit socket RIBE, M8, 240 mm	1	80	913.1475	Extension drive, large	1
53	911.1526	1/2" Bit socket Torx, long, T45	1	67	911.5313	Hex bit socket, ball ended, long, 1/2", 6 mm	1	81	913.1474	Extension drive, small	1
54	911.1527	1/2" Bit socket Torx, long, T50	1	68	911.1960	1/2" Bit socket hexagon, 10 mm, 140 mm	1				
55	911.1528	1/2" Bit socket Torx, long, T55	31	69	911.1980	1/2" Bit socket RIBE, M10, 140 mm	1				

**M** Screw spanner set

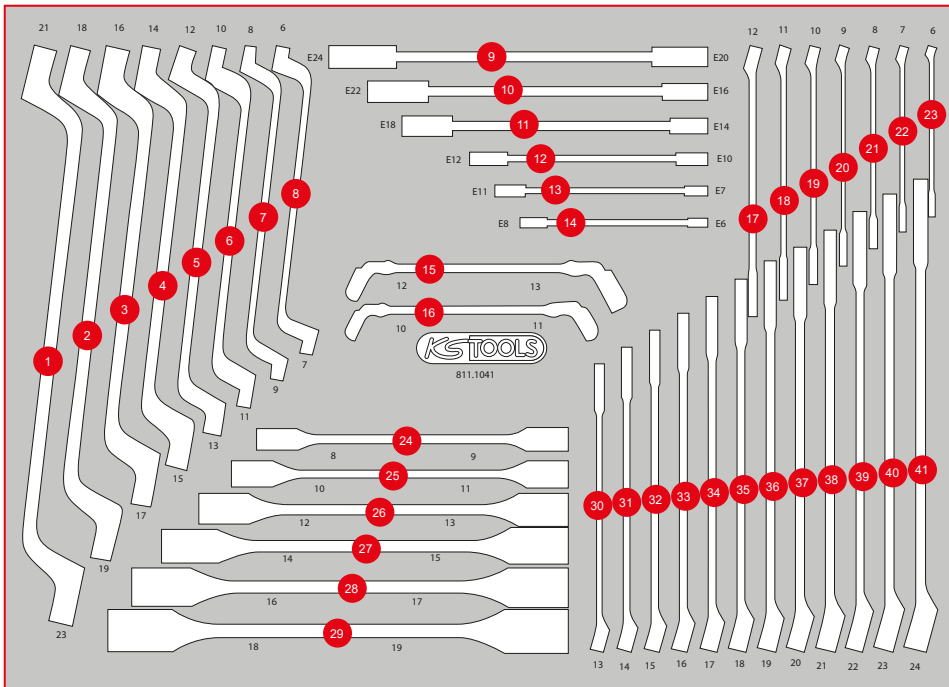

Pos.	Code	Description	pcs
1	517.0815	Double ring spanner, offset, 21 x 23 mm	1
2	517.0812	Double ring spanner, offset, 18 x 19 mm	1
3	517.0810	Double ring spanner, offset, 16 x 17 mm	1
4	517.0809	Double ring spanner, offset, 14 x 15 mm	1
5	517.0807	Double ring spanner, offset, 12 x 13 mm	1
6	517.0804	Double ring spanner, offset, 10 x 11 mm	1
7	517.0802	Double ring spanner, offset, 8 x 9 mm	1
8	517.0801	Double ring spanner, offset, 6 x 7 mm	1
9	911.0376	Double ring spanner for Torx E profile, E20 x E24	1
10	911.0375	Double ring spanner for Torx E profile, E16 x E22	1
11	911.0374	Double ring spanner for Torx E profile, E14 x E18	1
12	911.0373	Double ring spanner for Torx E profile, E10 x E12	1
13	911.0372	Double ring spanner for Torx E profile, E7 x E11	1
14	911.0371	Double ring spanner for Torx E profile, E6 x E8	1
15	518.0529	Open double ring spanner, with double joint, 12 x 13 mm	1
16	518.0528	Open double ring spanner, with double joint, 10 x 11	1
17	517.0612	Combination spanners, offset, 12 mm	1
18	517.0611	Combination spanners, offset, 11 mm	1
19	517.0610	Combination spanners, offset, 10 mm	1
20	517.0609	Combination spanners, offset, 9 mm	1
21	517.0608	Combination spanners, offset, 8 mm	1
22	517.0607	Combination spanners, offset, 7 mm	1
23	517.0606	Combination spanners, offset, 6 mm	1
24	517.0301	Double revolving head spanner, 8 x 9 mm	1
25	517.0302	Double revolving head spanner, 10 x 11 mm	1
26	517.0303	Double revolving head spanner, 12 x 13 mm	1
27	517.0304	Double revolving head spanner, 14 x 15 mm	1
28	517.0305	Double revolving head spanner, 16 x 17 mm	1
29	517.0306	Double revolving head spanner, 18 x 19 mm	1
30	517.0613	Combination spanners, offset, 13 mm	1
31	517.0614	Combination spanners, offset, 14 mm	1
32	517.0615	Combination spanners, offset, 15 mm	1
33	517.0616	Combination spanners, offset, 16 mm	1
34	517.0617	Combination spanners, offset, 17 mm	1
35	517.0618	Combination spanners, offset, 18 mm	1
36	517.0619	Combination spanners, offset, 19 mm	1
37	517.0620	Combination spanners, offset, 20 mm	1
38	517.0621	Combination spanners, offset, 21 mm	1
39	517.0622	Combination spanners, offset, 22 mm	1
40	517.0623	Combination spanners, offset, 23 mm	1
41	517.0624	Combination spanners, offset, 24 mm	1

811.0019

**M** Pliers and file set

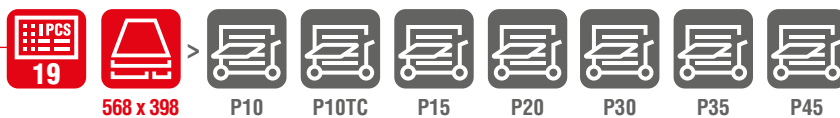

Pos.	Code	Description	pcs
1	157.0405	Tri-bastard file, form C, cut 2, 200 mm	1
2	157.0105	Halfround file, form E, cut 2, 20 mm	1
3	157.0005	Flat file, form B, cut 2, 200 mm	1
4	157.0205	Round file, form F, cut 2, 200 mm	1
5	907.2166	Snap off blades 0,5 x1 8 x 100 mm, dispenser with 10 pieces	10
6	300.0114	Tape measure with locking device and belt clip, black red, 5 m, 19 mm	1
7	300.0510	Pocket vernier calliper 0-150 mm, 235 mm	1
8	300.0600	Feeler gauge, 20 Blades, 0,05-1 mm	1
9	907.2135	Universal snap off blade knife 18 mm	1
10	115.1033	Self grip wrench, 220 mm	1
11	115.2010	Water pump pliers, 240 mm	1
12	500.1026	Circlip pliers for external circlips, angled, 160 mm	1
13	500.1029	Circlip pliers for external circlips, 160 mm	1
14	500.1032	Circlip pliers for internal circlips, angled, 160 mm	1
15	500.1035	Circlip pliers for internal circlips, 160 mm	1
16	115.1012	ERGOTORQUE diagonal side cutter, 160 mm	1
17	115.1021	ERGOTORQUE combination pliers, 180 mm	1
18	115.1019	ERGOTORQUE bent nose pliers serrated, 210 mm	1
19	115.1024	ERGOTORQUE long nose pliers serrated cutter, 200 mm	1

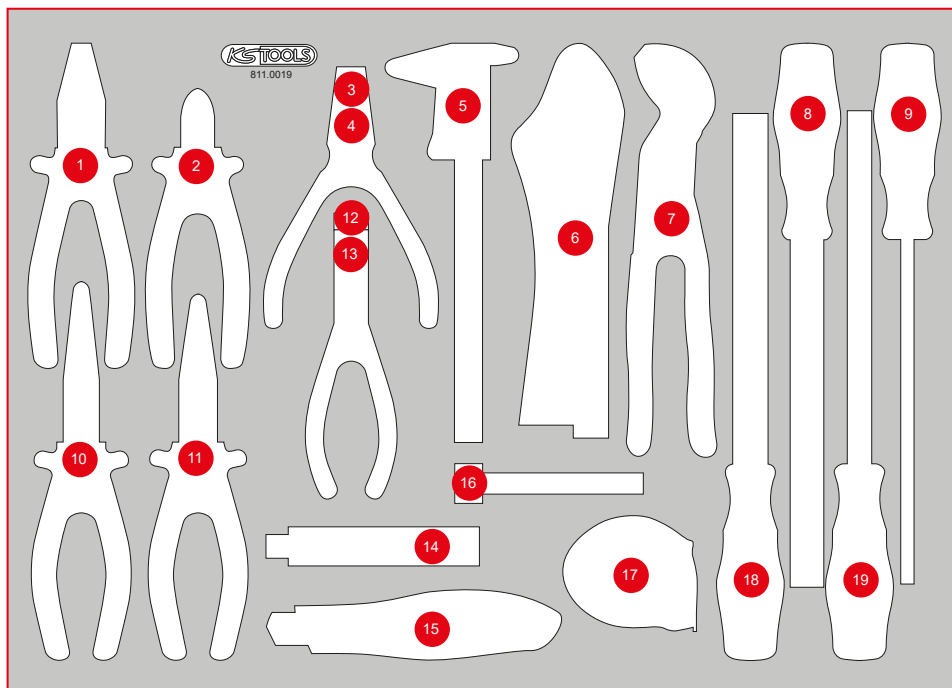

811.0043

**M** Oil and tyre servicing set



568 x 398



P10



P10TC



P15



P20



P30



P35



P45



Pos.	Code	Description	pcs	Pos.	Code	Description	pcs	Pos.	Code	Description	pcs
1	150.2222	Brake piston reset device, 3/8"	1	8	150.9116	3/8" Oil service bit socket 12 mm for internal square screws	1	14	150.9124	3/8" Oil service bit socket 9 mm for internal square screws	1
2	150.9120	3/8" Oil service bit socket for internal square screws, 3/8" mm	1	9	150.9117	3/8" Oil service bit socket 13 mm for internal square screws	1	15	150.9125	3/8" Oil service bit socket 10 mm for internal square screws	1
3	150.9119	3/8" Oil service bit socket for internal square screws, 5/16" mm	1	10	150.9118	3/8" Oil service bit socket 14 mm for internal square screws	1	16	150.9126	3/8" Oil service bit socket 12 mm for internal square screws	1
4	150.9111	3/8" Oil service bit socket for internal square screws, 7 mm	1	11	150.9122	3/8" Oil service bit socket 10 mm for internal square screws	1	17	150.9127	3/8" Oil service bit socket 14 mm for internal square screws	1
5	150.9112	3/8" Oil service bit socket for internal square screws, 8 mm	1	12	150.9121	3/8" Oil service bit socket 10 mm for internal square screws	1	18	150.9128	3/8" Oil service bit socket 17 mm for internal square screws	1
6	150.9113	3/8" Oil service bit socket for internal square screws, 10 mm	1	13	150.9123	3/8" Oil service bit socket 8 mm for internal square screws	1	19	150.2153	1/2" Brake calliper bit socket, pentagon, 10 mm	1
7	150.9114	3/8" Oil service bit socket for internal square screws, 11 mm	1					20	150.2154	1/2" Brake calliper socket, pentagon, 14 mm	1

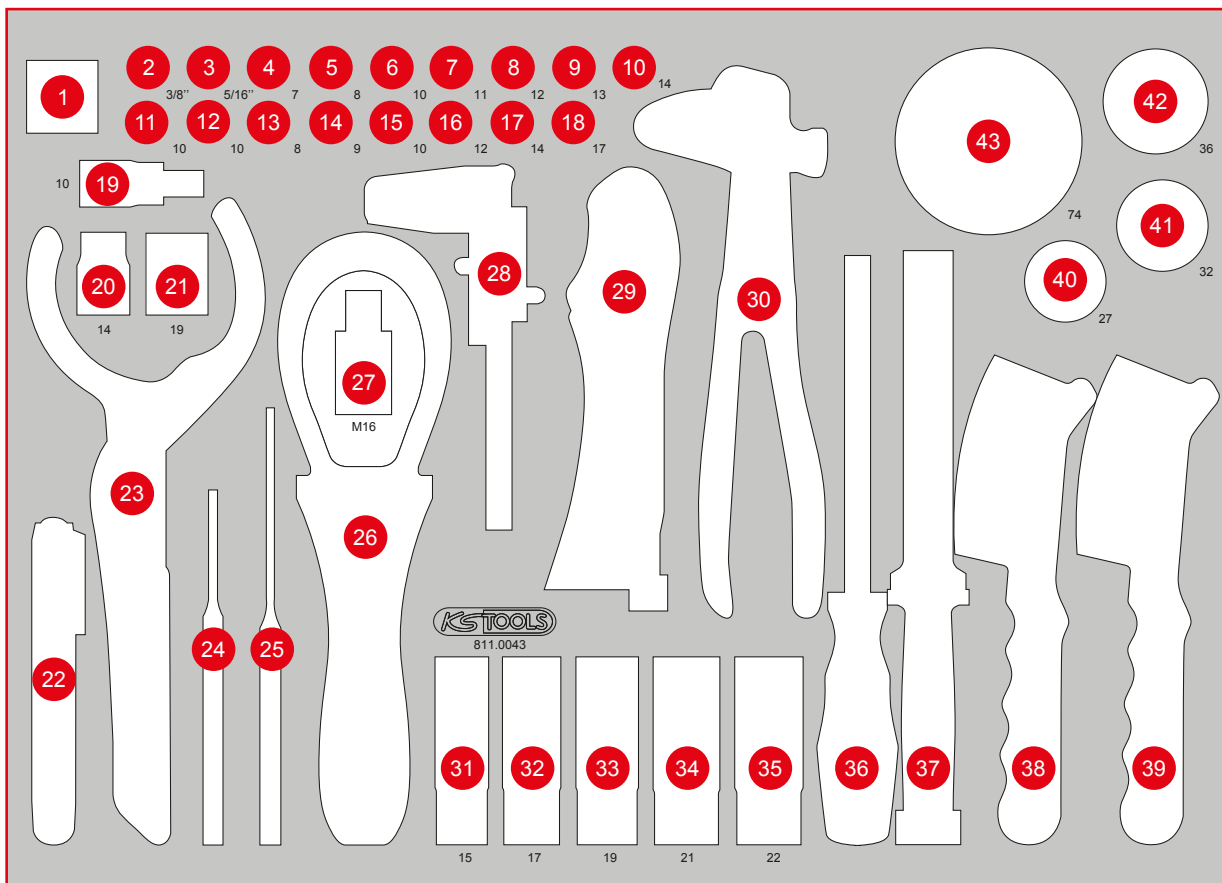

Pos.	Code	Description	pcs	Pos.	Code	Description	pcs	Pos.	Code	Description	pcs
21	150.2155	1/2" Brake calliper socket, pentagon, 19 mm	1	29	115.1175	Round jaw-American type, 175 mm	1	35	515.0995	SlimPOWER 1/2" Alloy rim impact socket, 22 mm	1
22	150.2199	Brake fluid tester	1	30	150.2025	Wheel balance weight pliers, 250 mm	1	36	157.0960	Brake saddle file, extra narrow, 270 mm	1
23	150.9317	Oil filter pliers, 50-125 mm	1	31	515.0991	SlimPOWER 1/2" Alloy rim impact socket, 15 mm	1	37	911.8132	Glass fibre chisel, 22 mm	1
24	156.0114	Pin punch octagonal shaft, mirror polished, Ø 5 mm	1	32	515.0992	SlimPOWER 1/2" Alloy rim impact socket, 17 mm	1	38	201.2335	Steel wire brake saddle brush, 2-row, straight	1
25	156.0122	Pin punch octagonal shaft, mirror polished, extra long, Ø 4 mm	1	33	515.0993	SlimPOWER 1/2" Alloy rim impact socket, 19 mm	1	39	201.2340	Brass wire brake saddle brush, 2-row, curved	1
26	155.5005	Oil filter band wrench, Ø 65-105 mm	1	34	515.0994	SlimPOWER 1/2" Alloy rim impact socket, 21 mm	1	40	150.9217	3/8" Universal Oil filter band wrench, SW 27 mm	1
27	911.1348	1/2" Bit socket spline (XZN) tamperproof, M16, 55 mm	1					41	150.9218	3/8" Universal Oil filter band wrench, SW 32 mm	1
28	300.0535	Brake disk vernier calliper, 0-60 mm, 162 mm	1					42	150.9219	3/8" Universal Oil filter band wrench, SW 36 mm	1
								43	150.9215	3/8" Oil filter wrench, 74,2 mm, 14 grooves	1

**M** Hammer and chisel set



Pos.	Code	Description	pcs
1	911.8138	Trim plastic wedge, 195 x 30 mm	1
2	140.5252	Recoil free soft faced Hammer, 400 g	1
3	142.1402	Fitters Hammer, fiberglas handle, 400 g	1
4	142.5101	Club Hammer, fiberglas handle, 1000 g	1
5	550.1025	Flexible magnet lifter, 510 mm, Øhead=15 mm	1
6	550.1001	2in1 Telescopic solenoid holder with washer jet cleaning and setting tool, 150 - 675 mm	1
7	150.4370	perfectLight torch 85 lumen	1
8	911.8146	Tyre lever, 370 mm	1
9	201.2335	Steel wire brake saddle brush, 2-row, straight 225 mm	1
10	156.0241	Flat chisel, octagon, 20 mm	1
11	156.0254	Flat chisel, octagon, 18 mm	1
12	156.0242	Cross chisel, octagon, 7 mm	1
13	156.0243	Centre punch, octagon 10 mm	1
14	156.0244	Punch, Ø 5 mm, conical	1
15	156.0238	Punch, Ø 4 mm, conical	1
16	156.0237	Punch, Ø 3 mm, conical	1
17	156.0231	Pin punch, Ø 3 mm, cylindrical shaft	1
18	156.0232	Pin punch, Ø 4 mm, cylindrical shaft	1
19	156.0233	Pin punch, Ø 5 mm, cylindrical shaft	1
20	156.0234	Pin punch, Ø 6 mm, cylindrical shaft	1
21	156.0235	Pin punch, Ø 8 mm, cylindrical shaft	1
22	907.2232	Gasket scraper, 25 x 200 mm	1

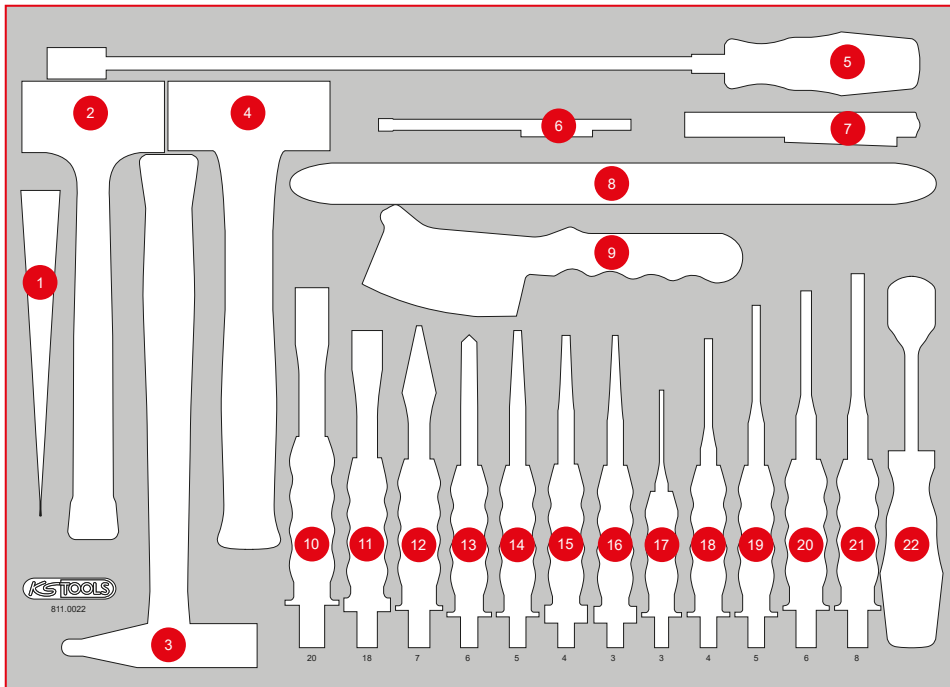

# P15

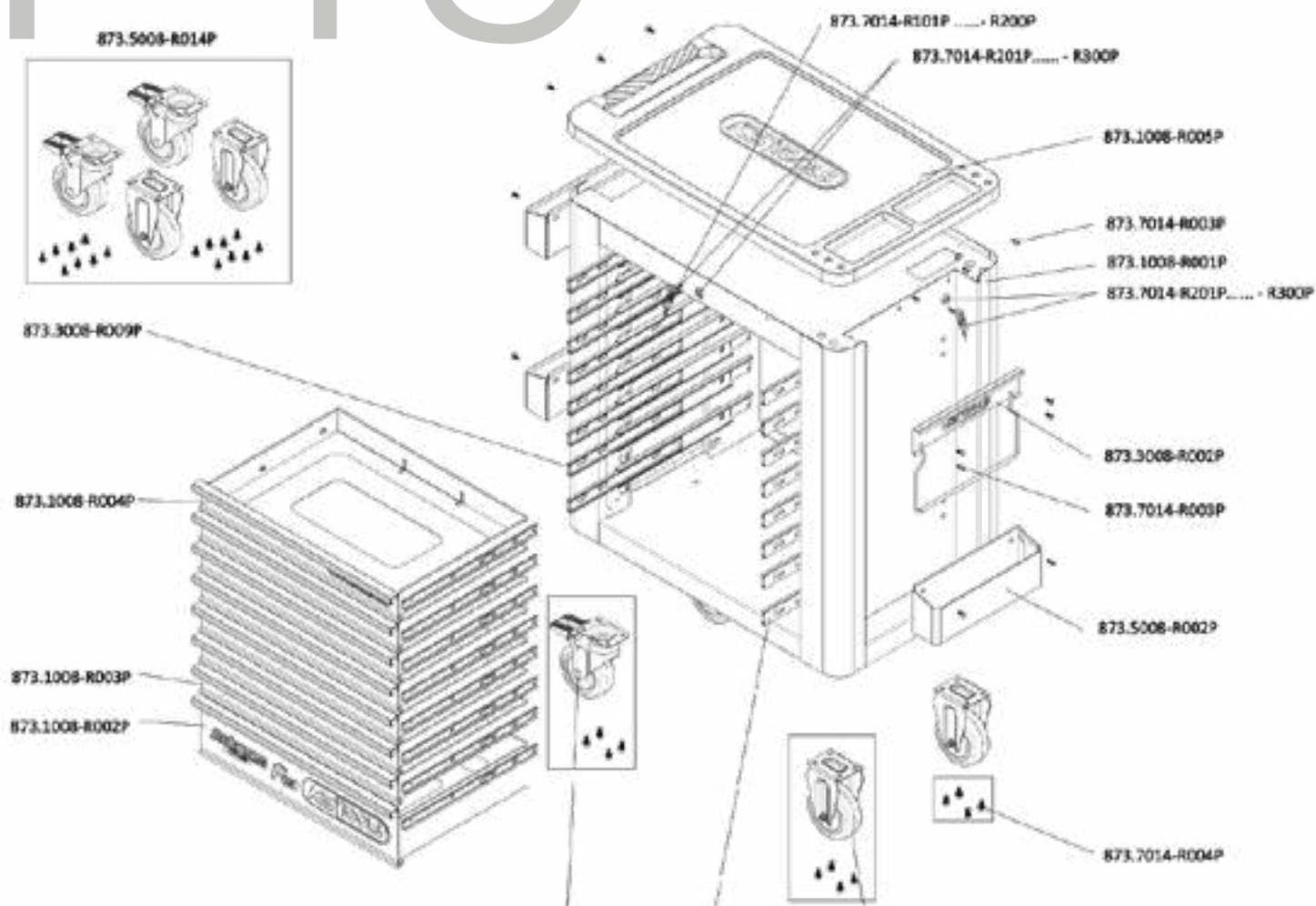

## INDIVIDUAL PARTS LIST

Art.-Nr.	Description	amount
873.7014-R101P...	Replacement key for PERFORMANCEplus workshop trolley lock number xyz	2
873.7014-R201P...	Lock with 2 keys for PERFORMANCEplus workshop trolley lock number xyz	2
873.1008-R001P	Body of workshop trolley	1
873.1008-R002P	Compartment with logo and ball-bearing guide, 568x398x145 mm	1
873.1008-R003P	Compartment with ball-bearing guide, for workshop trolley P10/P10TC/P15, 568x398x65 mm	6
873.1008-R004P	Compartment with website and ball-bearing guide, for workshop trolley P10/P15, 568x398x65 mm	1
873.1008-R005P	Plastic work surface with handle	1
873.3008-R002P	Paper roll holder for PERFORMANCEplus workshop trolley P10/P15/P25	1
873.3008-R008P	Full extension (with ball-bearing guide) with automatic retraction	8
873.3008-R009P	Full extension (with ball-bearing guide) with automatic retraction	8
873.5008-R002P	Can holder for PERFORMANCEplus workshop trolley P10/P15/P25/P35	3
873.5008-R009P	Fixed castors for PERFORMANCEplus workshop trolley, incl. screws	2
873.5008-R011P	Swivel castors with brakes, for PERFORMANCEplus workshop trolley, incl. screws	2
873.5008-R014P	Roller set for PERFORMANCEplus workshop trolley, incl. screws	1
873.7014-R003P	M6x12 screw (1 pcs.) for PERFORMANCEplus workshop trolley accessories	16
873.7014-R004P	M8 screws for PERFORMANCEplus workshop trolley rollers (16 pcs.)	1



**873.7014-R101P...R200P**  
Replacement key for lock number xyz



**873.7014-R201P...R300P**  
Lock with 2 keys, lock number xyz



**873.3008-R008P**  
Full extension (with ball-bearing guide) with automatic retraction, right



**873.3008-R009P**  
Full extension (with ball-bearing guide) with automatic retraction, left



**873.5008-R009P**  
Fixed castors, incl. screws



**873.5008-R011P**  
Swivel castors with brakes, incl. screws



**873.5008-R014P**  
Roller set, incl. screws



**873.1008-R005P**  
Plastic work surface with handle



**873.1008-R004P**  
Compartment with website and ball-bearing guide, 568x398x65 mm



**873.1008-R003P**  
Compartment with ball-bearing guide, 568x398x65 mm



**873.1008-R002P**  
Compartment with logo and ball-bearing guide, 568x398x145 mm



**873.5008-R002P**  
Can holder including screws, W = 310 mm



**873.3008-R002P**  
Paper roll holder including screws, W= 320 mm



**873.7014-R004P**  
M8 screws (16 pcs.)



**873.7014-R003P**  
M6x12 screw (1 pcs.)



**873.1008-R001P**  
Body of workshop trolley



The only thing that can't be replaced is the quality!